



**EDWARDS**



**FireWorks<sup>®</sup>**  
Incident Management Platform





## **MODERN INCIDENT MANAGEMENT.**

Large-scale security events are on the minds of the public more than ever before. Whatever the incident—fire, mass shooting, chemical disaster or domestic disturbance—FireWorks is ready to provide coordinated, timely communications during threats to public safety.

## **SCALABILITY MATTERS.**

Uniquely flexible and scalable, FireWorks functions as a single-seat monitoring and control system for stand-alone buildings and expansive campuses alike. It's intentionally designed to change with your physical structure over time.

## **ENGINEERED FOR ANY APPLICATION.**

FireWorks is ideal for environments with diverse needs, including high-rise buildings, campuses, airports or transit hubs, data centers, industrial environments, prisons, military bases and other globally dispersed organizations.

## **CERTIFIED TO SUCCEED.**

Rest assured that FireWorks will meet your distinct demands—because it has already met those of the most stringent certification agencies, including UL, ULC, and FM.





# A THOUSAND COMPLEX FACTORS. ONE CLEAR PLAN OF ACTION.

When chaos ensues, you need a system that brings cascading, ever-changing events into sharp focus. You need FireWorks®, the incident management platform that utilizes fire alarm and other building systems to create a top-level incident response protocol.

It's a sophisticated, smart way to drive swift, decisive and effective action.



# THE RIGHT RESPONSE SAVES LIVES.

FireWorks strengthens your response capabilities with a variety of notification methods that can be deployed in any combination to deliver targeted, clear alerts.



Voice audio / Visual notifications / SMS text messaging  
Email alerts / Mass notifications / Electronic signage

## A SYSTEM YOU CAN COUNT ON.

FireWorks is engineered for flexibility, supporting your numbers as they change over time.



**DEPLOYMENT  
OPTIONS**

-  Stand-alone system with **1** operator
-  Non-redundant network with up to **15** operators
-  Redundant network with up to **30** operators



**UP TO  
15  
REMOTE  
CLIENTS**

With monitor-only access

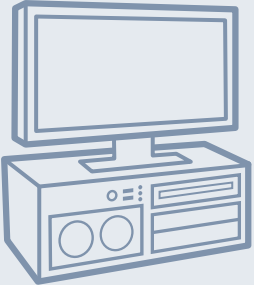

**GET A  
COMPLETE  
VIEW**

**FROM A SINGLE SYSTEM  
WITH UP TO:**

---

- 25** EST4 Panel Networks
- 125** EST3(X) Panel Networks
- 1,000** Edwards intelligent addressable panels
- 3,200** Dial-up or **500** IP Contact ID accounts
- 800** Network relays or VoIP modules

**UP TO  
20  
VESDA HLI  
UNITS**

Supporting up to 61 Xtralis Vesda detectors per HLI in a UL-Listed system

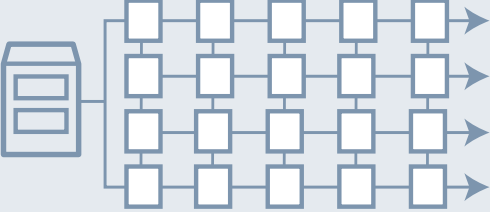

# SYSTEM COMPONENTS

Any incident response begins when a connected system alarms and triggers the FireWorks software. What follows is a situation-relevant sequence of events that delivers clear messaging for prompt action.

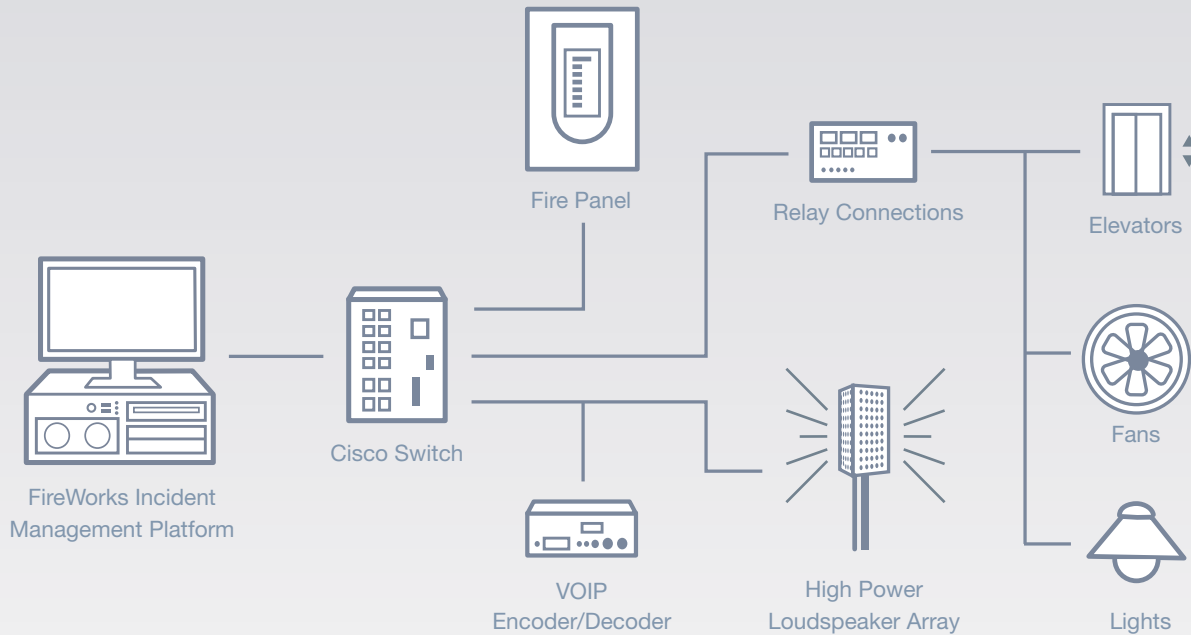

For illustrative purposes only. Not intended as a source for building system designs.



## Cisco® Switches

Connect all system components together, even when wiring is not feasible or cost efficient.



UL864 and UL2572 compliant switches powered by CISCO technology



## Relay Connections

Control and supervise external equipment that can be operated with a relay switch, such as fans, elevators, lights, fire panels, emergency weather radios, chemical detection and other threat-detection equipment.



## VOIP Encoder/Decoder

Establish voice communication capabilities for mass notification applications.



## Hyperspike Series High Power Loudspeaker Array (HPLA)

Issue audio mass messages with speakers that produce some of the industry's clearest (up to .91 STI, source-dependent) and loudest (up to 126 dBA Fast at 1m) audio signals. Its five-panel design produces optimum acoustics, and its light weight reduces installation costs.





## CUSTOMIZABLE SOLUTIONS THROUGH A DEDICATED PARTNER NETWORK.

Some of the world's most impressive structures—from the Bibliotheca Alexandrina Museum in Egypt to the modern-day Sphinx at the Luxor Hotel in Las Vegas—are designed, owned and occupied by professionals who have chosen Edwards to secure their facilities. That's because our partners—the people we entrust with our technology—provide unrivaled support and know-how to create custom life-safety solutions that lead the industry in innovation. And they're ready to do the same for you.

See what's possible for your business. Contact your EDWARDS Partner today.



LIFE SAFETY & INCIDENT MANAGEMENT

edwards.fire@carrier.com  
edwardsfiresafety.com

8985 Town Center Parkway  
Bradenton, FL 34202

©2022 Carrier  
All rights reserved.



E85006-0061 rev 2.2