

FLAMERANGER

autonomous fire suppression system

Design and Installation Manual REV 2.1



FLAMERANGER INSTALLATION MANUAL

Rev 2.0 May 2021

INTRODUCTION



Flame detector FV311S
IR array detector



Flame detector FV311S
IR array detector



UNIFIRE FORCE 50
Stainless Steel 316L Robotic nozzle with high precision brushless DC motors

Use this manual with the FLAMERANGER Autonomous Fire Suppression System.

Planning, design, installation, operation, and maintenance of the system must conform to the limitations detailed in this manual. An individual holding current certification from a FLAMERANGER system training program with training to plan, design, install, operate, recharge, and maintain FLAMERANGER Autonomous Fire Suppression systems must install and maintain these systems.

Read this manual in its entirety to plan, install, operate, reset, program, inspect, or maintain these fire suppression systems. Specific sections are of particular interest depending upon one's responsibilities.

As with all electrical, mechanical, and pneumatic equipment, the system needs periodic care to provide maximum assurance that it operates effectively and safely. Inspection and maintenance tasks shall be performed at least in accordance with the intervals as indicated in this manual, or more frequently, depending on operating and environmental conditions.

The application and use of the FLAMERANGER Autonomous Fire Suppression System is limited to the applications and uses described in this manual. For other applications, contact your Authorized FLAMERANGER Distributor, Territory Manager, or UNIFIRE AB Technical Services.

Note: Measurements given in this manual are according to the SI system (International System of Units). The converted values in this manual are provided for dimensional reference only and do not reflect an actual measurement.

Disclaimer:

UNIFIRE AB does not make any representations, warranties, or guarantees, expressed or implied, as to the accuracy or completeness of the manual. Users must be aware that updates and amendments will be made from time to time to the manual. It is the user's responsibility to determine whether there have been any such updates or amendments. Neither UNIFIRE AB nor any of its directors, officers, employees, or agents shall be liable in contract, tort, or in any other manner to any person for any loss, damage, injury, liability, cost, or expense of any nature, including without limitation incidental, special, direct, or consequential damages arising out of or in connection with the use of the manual.

All instructions contained herein relate to a typical installation.

Date: 2020-05-18

FLAMERANGER, FV300, and the product names listed in this material are marks and/or registered marks. Unauthorized use is strictly prohibited.

WARNING DEFINITIONS

DANGER

Indicates a hazardous situation in which a person **will experience serious personal injury or death** if the situation is not avoided.

! WARNING

Indicates a hazardous situation in which a person **could experience serious personal injury or death** if the situation is not avoided.

! CAUTION

Indicates a hazardous situation in which a person **could experience minor or moderate personal injury** if the situation is not avoided.

CAUTION

Addresses practices not related to personal injury, such as a system part malfunctioning, property damage, or system failure.

NOTICE

Addresses general practices or observations related to system function that are not related to personal injury.

About This Manual

Pending confirmation : (This manual is a comprehensive guide that contains the information necessary to design, install, operate, and maintain the FLAMERANGER Autonomous Fire Suppression system.)

Users of this manual are assumed to be competent fire engineers with a basic knowledge of such systems. Users who are not familiar with the equipment should first read the complete manual.

Only certified personal who have undergone UNIFIRE AB training are allowed to install this equipment.

Contacts

Should any part of this manual not be understood, or there are queries concerning the system, contact UNIFIRE AB Technical Support using the following details:

UNIFIRE AB,
Bultgatan 40B
442 40 KUNGÄLV
SWEDEN

Tel +46 303 248400

Mail: support@unifire.com

www.unifire.com

www.flameranger.com

APPROVALS AND STANDARDS

See Section 2 System Components for approval and listing information for the various components.

SAFETY warnings

A properly designed and installed fire suppression system should not present any significant health or safety problems. Take basic precautions to avoid accidents. The various aspects of the system's operation must be understood. Observe best practices.

! WARNING

Do not operate this device without a full understanding and comprehension of this manual. Personnel responsible for the FLAMERANGER system must be fully trained on the system components and required actions in the case of an alarm.

! WARNING

The installer should pay specific attention to the danger, caution, warning, and notice statements in this manual. Failure to observe safety warnings could cause serious injury, and potentially create liability.

! DANGER

Do not direct the flow stream towards people as it could result in serious personal injury or death.

- Operate and maintain the FLAMERANGER system in compliance with this document and with applicable standards, in addition to the standards of any other authorities having jurisdiction (AHJ). Failure to do so impairs the proper operation and integrity of this device.
- The owner must maintain the fire protection unit or system and devices in proper operating conditions.
- Do not, under any circumstance, operate this system outside the water flow or pressure range indicated in this manual.
- The owner must ensure that an uninterrupted supply of water is maintained to the Robotic Nozzle.





Authorized Personnel







The FLAMERANGER system shall be installed by authorized personnel certified by UNIFIRE AB. Use components and accessories authorized only by UNIFIRE AB.







Structural Alterations

This installation manual details the suggested installation method. Any structural alteration necessary for installation must comply with local building code requirements.

WARNINGS

 WARNING	<p>READ this instruction manual in its entirety prior to installing, maintaining, or using the Unifire Force™ ROBOTIC NOZZLE (AKA "Robotic nozzle" or "CANNON").</p> <p>Failure by any installer, maintenance personnel or operator to receive proper training, including reading and understanding this manual, prior to its use constitutes misuse of the equipment and could result in serious bodily injury or death and/or damage to the robotic nozzle or other property. Only qualified and trained professionals who are familiar with this equipment and general safety procedures may operate the Force robotic nozzle.</p> <p>The purpose of this Manual is to provide all users, installers, and maintenance personnel with the relevant information concerning the design, proper use, installation and maintenance of the equipment and should be read and made available to all such persons. This Manual will help prevent danger and injury to you and others. If you would like further copies of this manual, ask Unifire or download it at www.unifire.com. If you have any questions relating to this equipment and its safe use please contact Unifire prior to use at: Support@unifire.com</p>
 WARNING	<p>DO NOT ATTEMPT TO MODIFY THIS EQUIPMENT IN ANY WAY. Modification of the equipment may result in damage to, or malfunction of, the equipment, which could lead to serious injury of the operator and/or others. Internal inspection, maintenance and repairs should only be performed by, or under the specific, express authority of Unifire AB.</p>
 WARNING	<p>NEVER POINT THE FORCE 50 OR ANY Robotic nozzle DIRECTLY AT HUMANS WHILE WATER IS SPRAYING THROUGH IT, as doing so can result in serious injury or possibly death. The FORCE 50 is capable of directing flows of up to approximately 2000 liters per minute (540 gallons per minute) at pressures of up to 12 bars (175 psi) and has a maximum throwing range of up to approximately 65 meters (70 yards). Such forces are very dangerous and capable of producing serious injury or death to persons and serious damage to property. They are also capable of throwing objects with extreme force and velocity into other objects or persons. Accordingly, only professional, trained firefighters or other qualified individuals may operate this equipment after being thoroughly familiar with the Manual, and always by exercising extreme caution to avoid hitting people or lose objects with the water (or other fluid) stream.</p>
 WARNING	<p>BE SURE THAT THE ROBOTIC NOZZLE IS TIGHTLY AND PROPERLY SECURED AT ALL TIMES DURING OPERATION! Serious injury or death can occur if the robotic nozzle is not fully and properly secured and supported. Be sure that the mounting pipe for the FORCE 50 robotic nozzle is capable of withstanding a nozzle reaction force of at least eight thousand (8,000) Newtons (800 kgf). The FORCE 50 robotic nozzle should not be used on a portable stand of any kind, as such use can be extremely dangerous and can result in Serious Injury or Death.</p>

 WARNING	<p>The FORCE 50 IS HEAVY. Use caution and assistance when installing and take care to avoid injury to your back. Seek assistance to help support and twist the robotic nozzle during installation and take care to avoid injury to your back during handling and installation.</p>
 WARNING	<p>NEVER USE THE ROBOTIC NOZZLE AT PRESSURES HIGHER THAN 12 BARS (175 PSI). The maximum operating pressure for the FORCE 50 robotic nozzle is 12 bars (175 psi). Use of the FORCE 50 at pressures higher than 12 bars is dangerous and can lead to serious injury or death or may damage the robotic nozzle. Moreover, the recommended operating pressure of the FORCE 50 is between 7 and 8 bars (100 and 115 psi), which also will provide optimal performance.</p>
 WARNING	<p>ONLY MOUNT THE FORCE Robotic nozzle SO THAT ITS BASE IS PERPENDICULAR TO THE GROUND. DO NOT install the robotic nozzle at an angle or upside-down without the specific prior written consent of Unifire AB. Doing so may cause damage to the robotic nozzle gears and motors, which could lead to malfunction.</p>
 WARNING	<p>FOLLOW ALL MAINTENANCE & INSPECTION PROCEDURES in this manual.</p>
 WARNING	<p>Be sure to use the proper type and size of threads at the robotic nozzle base and also between the robotic nozzle and nozzle (if using a nozzle not supplied by Unifire specifically for use with this robotic nozzle). Use of the wrong type or size of threads will result in an improper connection which can cause leaking and also may cause the robotic nozzle and/or nozzle to dislodge under high pressure, possibly leading to serious injury or death to persons and/or serious damage to property. If you have any doubts as to the exact thread supplied by Unifire, contact Unifire for clarification prior to connecting the robotic nozzle and nozzle.</p>
 WARNING	<p>KEEP A SAFE DISTANCE DURING OPERATION AND MOVEMENT. The FORCE 50 Robotic nozzle has moving parts. Be sure to keep a safe distance from the robotic nozzle as it moves and keep hands and fingers away from pinch points to avoid injury.</p>
 WARNING	<p>AVOID RAPID CHARGING. Rapid charging of the robotic nozzle is potentially dangerous and can cause serious injury to persons and/or property and may cause damage to the robotic nozzle. Charge the robotic nozzle slowly to avoid creating a potentially dangerous, high-pressure surge.</p>

 WARNING	<p>USE ONLY UNIFIRE-APPROVED NOZZLES / NOZZLE TIPS. The FORCE 50 was designed for use with the Unifire INTEG 50 and Unifire Smooth Bore nozzles. Use of any nozzle other than a Unifire nozzle made for the FORCE 50 without specific, written approval in advance by Unifire AB constitutes misuse of the product and could affect the safety, performance and/or operation of the robotic nozzle. Such malfunctions could also result in the nozzle coming loose and being rapidly ejected with high force, which could cause serious injury or even death.</p>
 WARNING	<p>DO NOT OPERATE IN EXPLOSIVE ZONES OR ENVIRONMENTS! The electric motors and other components are potential ignition sources and could spark ignition if used in explosive environments. The FORCE 50 is not approved for operation in explosive environments and therefore it should never be used in such environments.</p>
 WARNING	<p>DO NOT IMMERSE EQUIPMENT IN WATER. Do not immerse the robotic nozzle, its control box (the TARGA PLC) nor the joystick in water and be sure to keep water out of their interiors. Unifire's robotic nozzles, and joystick are designed to withstand moderate exposure to rain and water splashing during normal use of the robotic nozzle. Prolonged or extreme exposure to water, including submersion, however, will cause damage and could also cause electrical shock resulting in injury. The TARGA PLC must be installed protected from water and dust. IP67 rated enclosure is optional.</p>
 WARNING	<p>Do not use the electrical controls during operation of the emergency manual override cranks as doing so could cause injury.</p>
 WARNING	<p>ONLY USE THE MANUAL OVERRIDE IN CASE OF TRUE EMERGENCY & POWER FAILURE. The manual override controls on the FORCE 50 are not designed for normal operation and should only be used in the case of extreme emergency and when the remote control feature is not working sufficiently to control the robotic nozzle by means of the electronic controls. In case of use in such an emergency, first disconnect the cables from the motor connections. !!</p>
 WARNING	<p>DISCONNECT POWER PRIOR TO INSTALLATION, MAINTENANCE OR REPAIR. Prior to installation, maintenance or repair be sure to disconnect power and disable flow.</p>





 WARNING	<p>Be sure to use the proper type and size of threads at the robotic nozzle base and also between the robotic nozzle and nozzle (if using a nozzle not supplied by Unifire specifically for use with this robotic nozzle). Use of the wrong type or size of threads will result in an improper connection which can cause leaking and also may cause the robotic nozzle and/or nozzle to dislodge under high pressure, possibly leading to serious injury or death to persons and/or serious damage to property. If you have any doubts as to the exact thread supplied by Unifire, contact Unifire for clarification prior to connecting the robotic nozzle and nozzle.</p>
 WARNING	<p>The FORCE 50 is heavy. EXERCISE caution and SEEK assistance when installing and take care to avoid injury to your back. Seek assistance to help support and twist the robotic nozzle during installation and take care to avoid injury to your back during handling and installation.</p>
 WARNING	<p>BE SURE THAT THE FORCE 50 IS TIGHTLY AND PROPERLY SECURED AT ALL TIMES DURING OPERATION! Serious injury or death can occur if the robotic nozzle is not fully and properly secured and supported. Be sure that the mounting pipe for the FORCE 50 is capable of withstanding a nozzle reaction force of at least eight thousand (8,000) Newtons (800 kgf). The FORCE 50 robotic nozzle should not be used on a portable stand of any kind, as such use can be extremely dangerous and can result in Serious Injury or Death.</p>
 WARNING	<p>NORMALLLY MOUNT THE FORCE Robotic nozzle SO THAT ITS BASE IS PERPENDICULAR TO THE GROUND.</p> <p>If you plan to install the robotic nozzle at an angle or upside-down, please consult UNIFIRE when ordering. Special gear ratio and programming may be required.</p>

TABLE OF CONTENTS			
FLAMERANGER INSTALLATION MANUAL			
REV 2.0 MAY 2021			
INTRODUCTION			
Disclaimer:	1-2	FV300 connection box terminal socket specifications	4-4
WARNING DEFINITIONS	1-3	FV300 generic wiring by TYCO	4-5
About This Manual	1-4	Wiring the detectors	4-6
Contacts	1-4	Main Power	4-6
APPROVALS AND STANDARDS	1-4	Selecting Cables	4-6
SAFETY warnings	1-4	Cable Entry Sealing (Gland Connectors)	4-6
Authorized Personnel	1-4	INSTALLATION CABLE TO THE DETECTORS	4-7
Structural Alterations	1-4	THE FLAMERANGER PLC CABINET	4-7
WARNINGS			
ACRONYM DEFINITIONS	1-6	ELECTRICAL INSTALLATION	
SAFETY Information	1-7	Generic TARGA PLC overview	4-8
Inspecting the FLAMERANGER System	1-7	TARGA PLC generic system overview	4-8
Rigging and Handling	1-7	TARGA PLC generic M12 pin-specification	4-9
System Components and accessories	1-9	Connecting the FORCE 50 to the TARGA PLC	4-10
Table 2: required components	1-9	FLAMERANGER PLC terminal socket specifications	4-13
PLANNING AND PREPARATION			
INTRODUCTION TO FLAMERANGER	1-11	SOFTWARE SETUP	
System Limitations	1-12	FLAMERANGER Geometry Setup	5-3
Building Construction	1-12	System Setup Example	5-4
Determining a Location	1-12	Calibrating the Robotic Nozzle's operating range	5-7
Determining the number of systems	1-12	Step-by-Step Instructions	5-10
INSTALLATION GEOMETRY OPTIONS	1-13	Step-by-Step Instructions (Continued)	5-11
Wall, normal orientation	1-13	Calibrating the INTEG jet/spray nozzle	5-12
Wall, inverted orientation	1-14	Set parking position	5-13
Ceiling, hanging orientation	1-15	Verify parking position	5-14
Installation on the wall	1-16	Status windows, Service book, rev versions etc..	5-15
Installation hanging from the ceiling	1-16	COMMISSIONING	
FLOW SETTINGS			
Nozzle Flow Setting	2-2	System Verification	7-2
Reach chart	2-3	Verify that the PLC is powered on	7-2
Flow chart	2-4	Verify that the web interface displays and is operational	7-2
MECHANICAL INSTALLATION			
Installing The Robotic Nozzle	3-2	Verify that the detectors operate and receive power	7-2
Installing the FV300 detectors	3-4	Verify that the robotic nozzle operate and move	7-2
ELECTRICAL INSTALLATION			
Electrical installation FLAMERANGER system overview:	4-2	Verify that the releasing panel is powered on.	7-2
FV300 electrical connections	4-3	Check for abnormalities	7-2
		CONFIGURING THE FV300 DETECTORS	
		Configuring the detectors	8-2

ACRONYM DEFINITIONS

Table 1 defines the acronyms in the user manual.

TABLE 1: ACRONYM DEFINITIONS

Acronym	Definition
AFS	Autonomous fire suppression
AHJ	Authority having jurisdiction
DSP	Digital signal processor
dm	Decimeter
ft	Foot (or Feet)
FACP	Fire alarm control panel
HR	Horizontal range
IR	Infrared
kg	Kilogram
lb (lbs)	Pound(s)
m	Meter
mm	Millimeter
Lpm	Liters per minute
PLC	Programmable logic controller
VDC	Volts of direct current
VDR	Vertical downward coverage range
VUR	Vertical upward coverage range

SAFETY Information

! DANGER

Shut off the power and isolate the system before carrying out any installation, repair, or maintenance steps. Electrical parts may cause injury or death.

Before installing the FLAMERANGER system, follow this safety information:

- Qualified personnel must carry out all installation steps.
- Follow the directions given in this manual.
- Safely secure the monitor and its components during installation.
- Use lifting gear, equipment, and procedures fit for purpose.

Inspecting the FLAMERANGER System

Before installing the FLAMERANGER system, complete the following inspection checks:

- Inspect the system components for damage or other deviations that might occur during transport. If damage is evident, note the extent of damage on the carrier's freight bill. A separate request for inspection by the carrier's agent should be made in writing. Damaged equipment shall not be installed.
- Check the marking and identification labels on the equipment against the material specification and order confirmation.



Rigging and Handling

!CAUTION

Take extreme caution and extreme safety measures when handling and installing the Robotic Nozzle.

The Robotic Nozzle is heavy, but as they are light enough to man-handle, there is a big risk that installer may not follow safety procedure, and be casual when handling the units.

Note that if the unit is dropped, it will be damaged, and this is NOT covered by warranty.

Dropping the nozzle may damage property and equipment, and may lead to severe injury or death if dropped on a person.

Be very, very careful during rigging and installation!!

! WARNING

The Robotic Nozzle can be oriented in 3 different ways. Always make sure you have sufficient mechanical support.

The FORCE 50 must have a support capable of withstanding 8 000 N of force

The FORCE 80 must have a support capable of withstanding 20 000 N of force

- Install the Robotic Nozzle as per the instructions provided for your project
- The Robotic nozzle may be installed level to ground, hanging upside-down from the ceiling, or at a 90° angle pointing to the ground
- All of the possible orientations may be used within a plant or project, so take special care when planning as your project may host all 3 versions.



! DANGER

DO NOT PRESSURIZE THE UNIT until the flange has been properly tightened.

DO NOT PRESSURIZE THE UNIT until the electrical installation and software calibration procedure has been completed

DO NOT PRESSURIZE THE UNIT until the system commissioning has been completed by certified technicians, and a formal release note / approval has been issued.



System Components and accessories

The FLAMERANGER system is a fully engineered integrated system that requires the use of specific proprietary components that must be used together to ensure proper functionality. Table 2 lists the required system components. For an additional list of recommended components and accessories, see Table 2-2.

For technical specifications and performance data, refer to the system component's applicable data sheet.

Table 2: required components

System component	Part number	Description	Certifications	Technical data sheet
FLAME DETECTOR	FV300SC	FV311S IR array flame detector (no camera)	ATEX, IECEx, FM, EN54, and CSA	
FORCE 50	F50B	FORCE 50 Robotic Nozzle		
INTEG 50	INT50B	INTEG 50 jet/spray		
TARGA PLC	TARGA3	Flameranger PLC		
Flameranger SW	FR	Flameranger Software licence		
Ammolite		Unifire Graphical user interface		
ONE App		Unifire Smartphone App		

PLANNING AND PREPARATION

**Please read this section when considering
to install the FLAMERANGER system**

INTRODUCTION TO FLAMERANGER

The FLAMERANGER Autonomous Fire Suppression system is designed to provide quick detection and immediate suppression of a fire that starts within the volume defined by the positions of the FV300 detectors.

Mechanically the system is compiled of 2 x FV300 flame detectors installed in the upper right and left corner of the protected volume, and one FLAMERANGER TARGA PLC, and one Robotic Fire Monitor, FORCE 50 or FORCE 80.

The detectors provide quick and accurate detection and 3D positioning of a fire within the protected volume.

When a flame has been detected, a large flow water stream is automatically aimed at the flames.

The system includes the FLAMEVision FV300 flame

detectors. This FV300 uses infrared array based sensing technology. An array of 256 infrared sensors, plus two optical channels, view the protected area. Powerful algorithms running on a DSP (digital signal processor) are tuned into fire characteristics to accurately and quickly read the signals from these channels, and reliably identify fires. The flame detectors identify the position of a flame, as well as the size and volume of the flame, and provide the coordinates to the PLC.

When the FV300 flame detectors detect flames, the system autonomously aims the Robotic Nozzle to directly target the identified fire, based on three dimensional coordinates. Once positioned, the valve actuates to open. Water flows through the Robotic Nozzle to suppress the identified fire.

This manual will guide you through planning, mechanical installation, system setup and calibration.

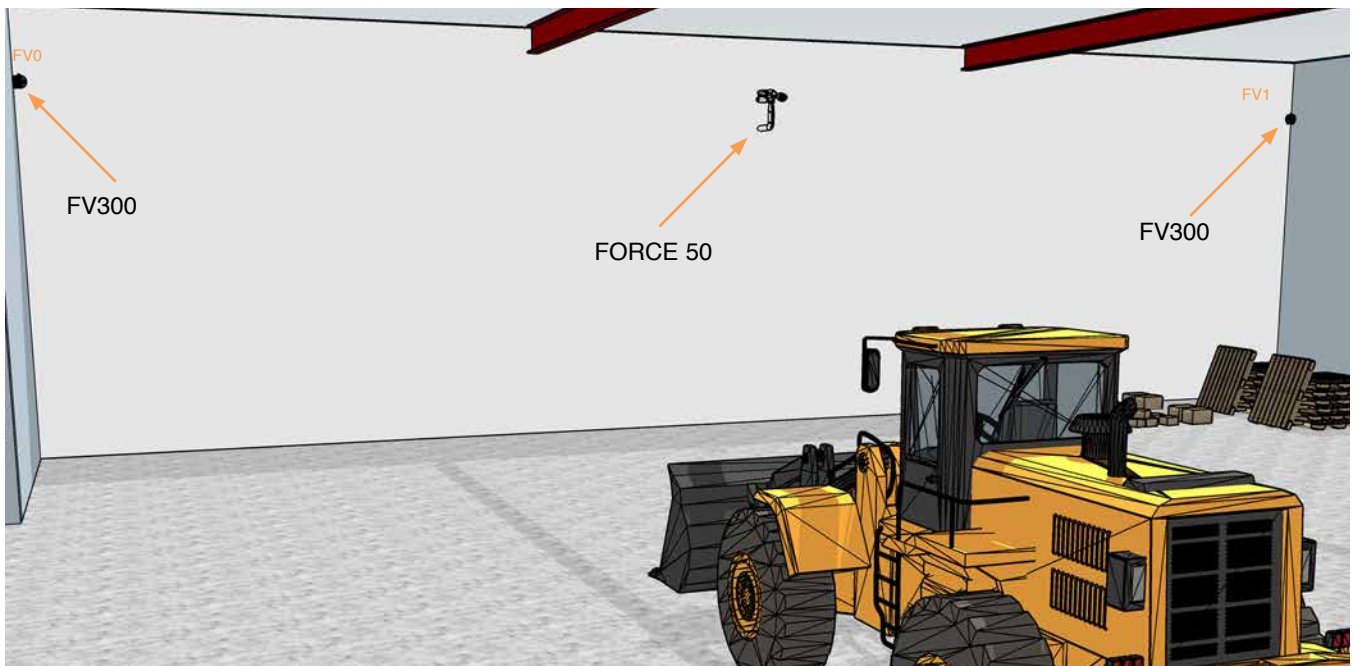

In tests conducted by US Navy, the system have water on the flames within 15 seconds from ignition.

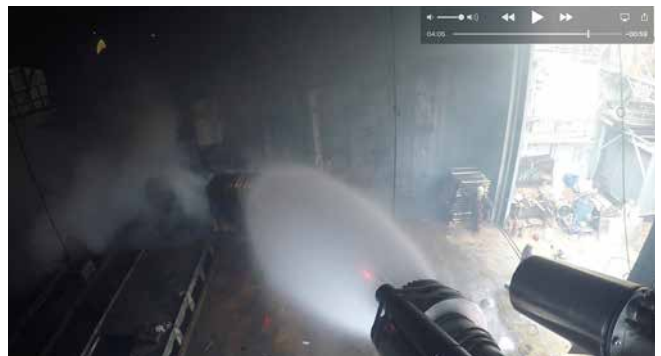

In this test with manually delayed activation, the system suppressed the fully developed flames within 8 seconds.

System Limitations

The system designer shall take into account the building construction requirements, location, hydraulic design, coverage area, and number of systems required. If the limitations in these areas are not maintained, the system may not operate correctly.

Building Construction

Before installing the FLAMERANGER system, the designer shall consider the following factors related to the building construction:

- **Unobstructed field of view:** The system designer must position the detectors in an unobstructed area to correctly identify the location of a flame.
- **Line of sight:** As the FV300 detectors are line of sight detectors, any object within the detector's field of view causes an unprotected shadow in the protected area (*i.e.*, any flames within the shadow will be undetectable). Small objects close to the detector can cause large shadows.

- **Water demand:** Evaluate the FLAMERANGER water system demand as an independent addition to the existing building water supply. Conduct a hydraulic analysis to ensure that it does not affect the building's existing water system design criteria. It is possible to achieve this without significant system supply modifications. However, the system may require increased pump sizes, storage tank capacity, and pipe sizes.

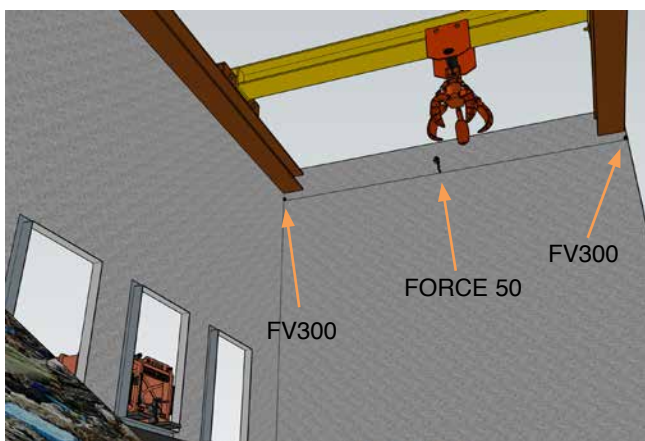

FLAMERANGER is installed in waste incineration plants

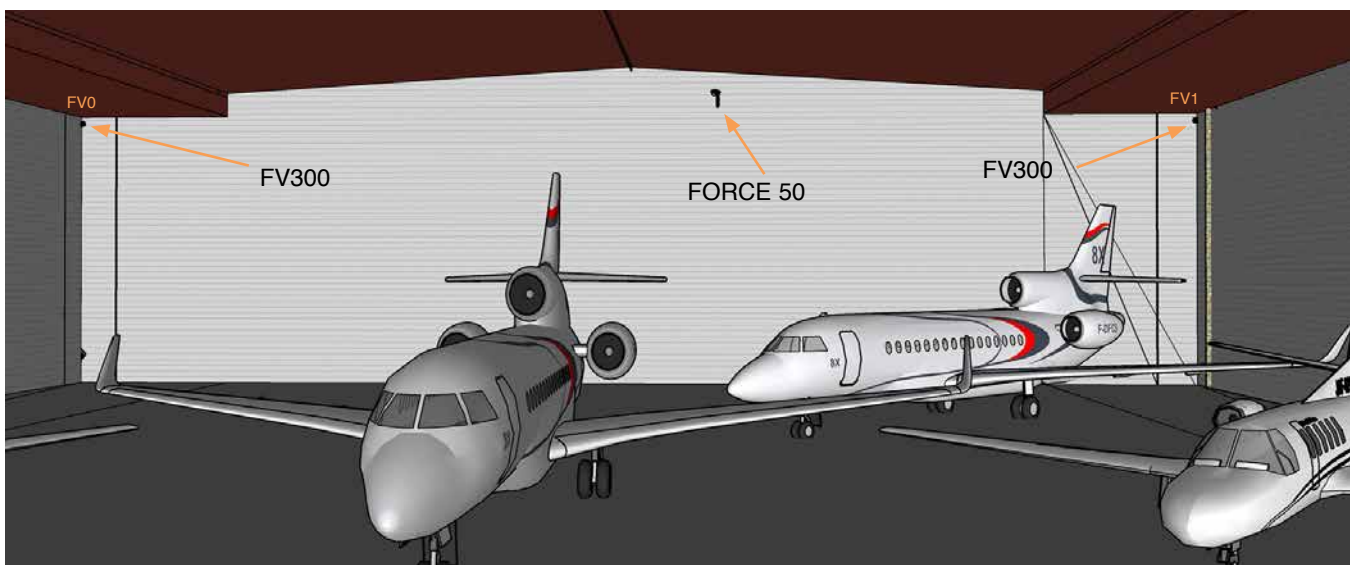

FLAMERANGER is the ideal fire protection system for Aircraft Hangars, and Aircraft Carriers

INSTALLATION GEOMETRY OPTIONS

The two detectors must be installed parallel, level to ground, on exactly the same level and angle.

The Robotic nozzle, however can be installed geometrically freely within the volume defined by the two detectors.

The Robotic nozzle can be installed with

Wall, Normal orientation

Wall, Inverted orientation

Ceiling, hanging orientation

Wall, normal orientation

Use when the water supply comes from below

Use when the Robotic Nozzle is installed on a wall, allowing a maximum of 180° horizontal and +/- 90° vertical movement. The TARGA PLC must be installed next to the Robotic Nozzle

This geometry is suitable for manual operation with Joystick.

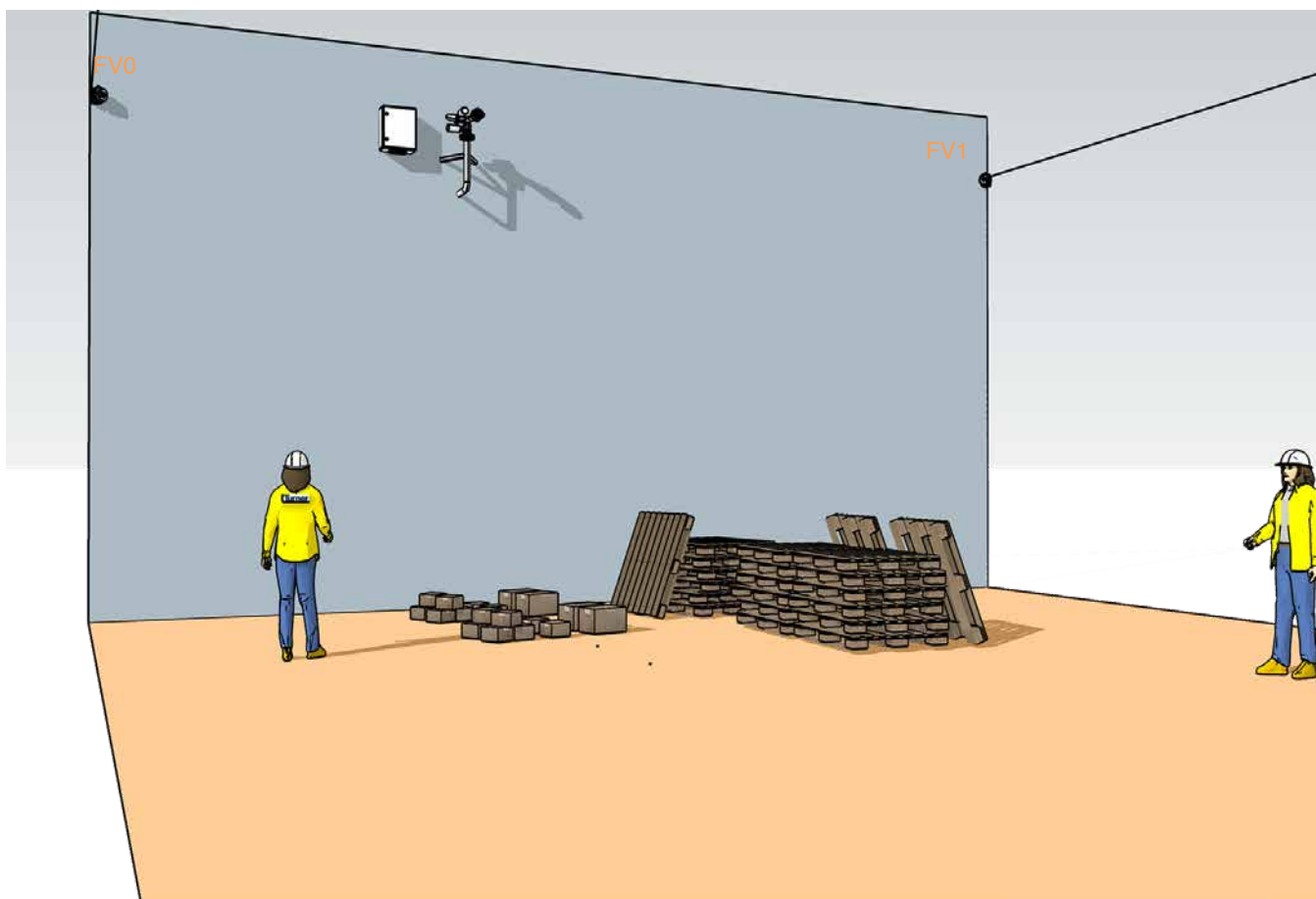
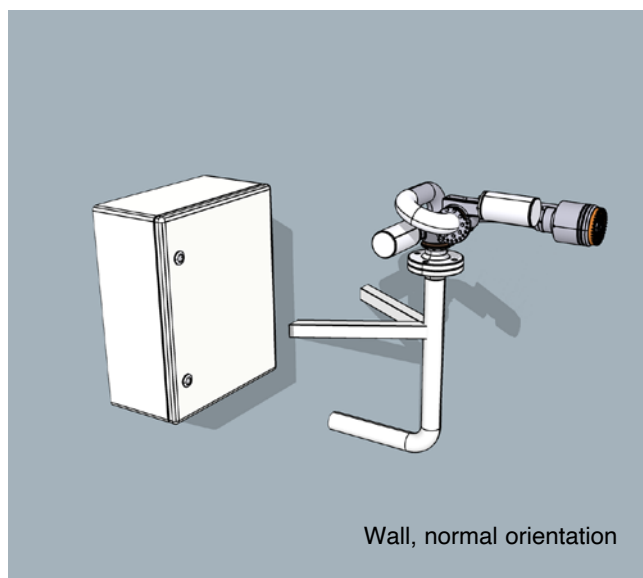

Wall, inverted orientation

Use when the water supply comes from above.

Use when the Robotic Nozzle is installed on a wall, allowing a maximum of 180° horizontal and +/- 90° vertical movement

The TARGA PLC must be installed next to the Robotic Nozzle.

This geometry is suitable for manual operation with Joystick

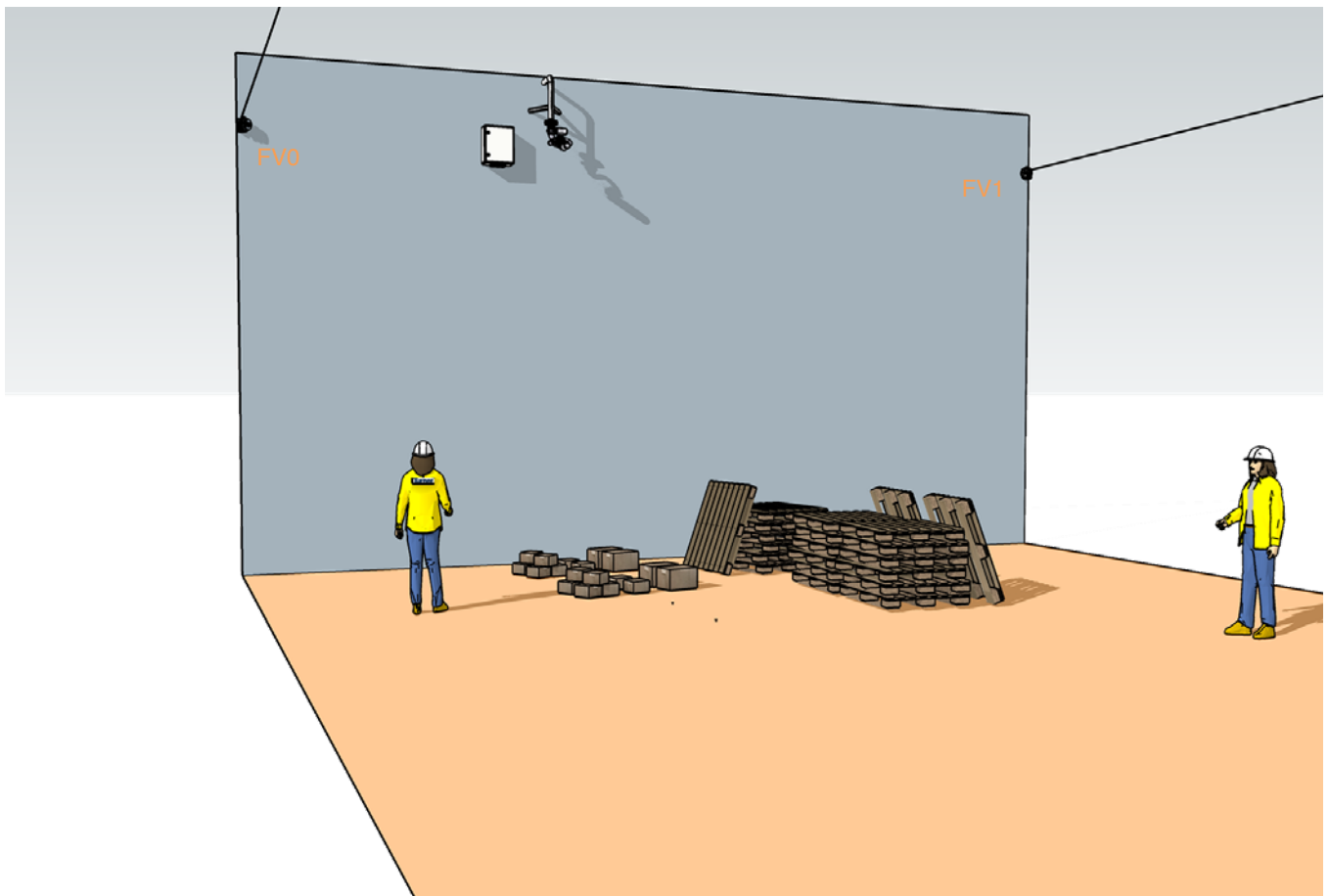
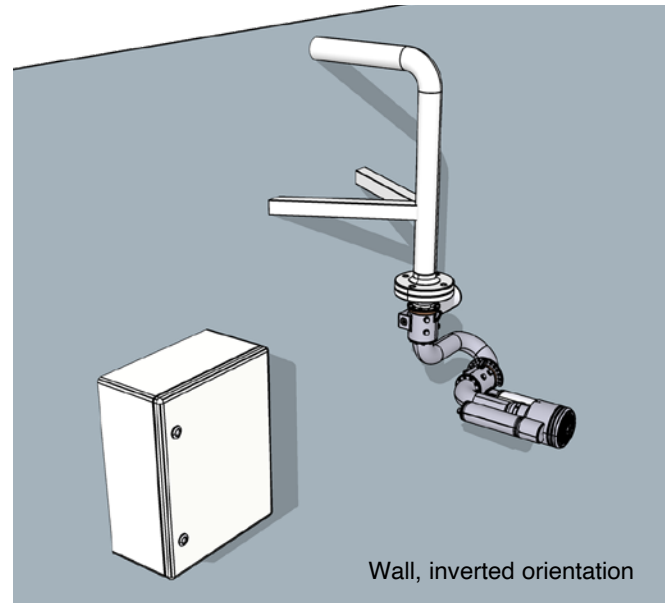

Ceiling, hanging orientation

Installing the Robotic Nozzle hanging from the ceiling usually provide the best reach and coverage.

The Robotic Nozzle can be installed in the center of the area covered by the detector, thus allowing a full 360° coverage of up to 70 m Ø (35 m reach in all directions)

This is usually the preferred orientation for autonomous systems - when the FORCE 50 is controlled from detectors or a Thermal imaging system.

This orientation is not suited for manual operation with a Joystick or the ONE App.

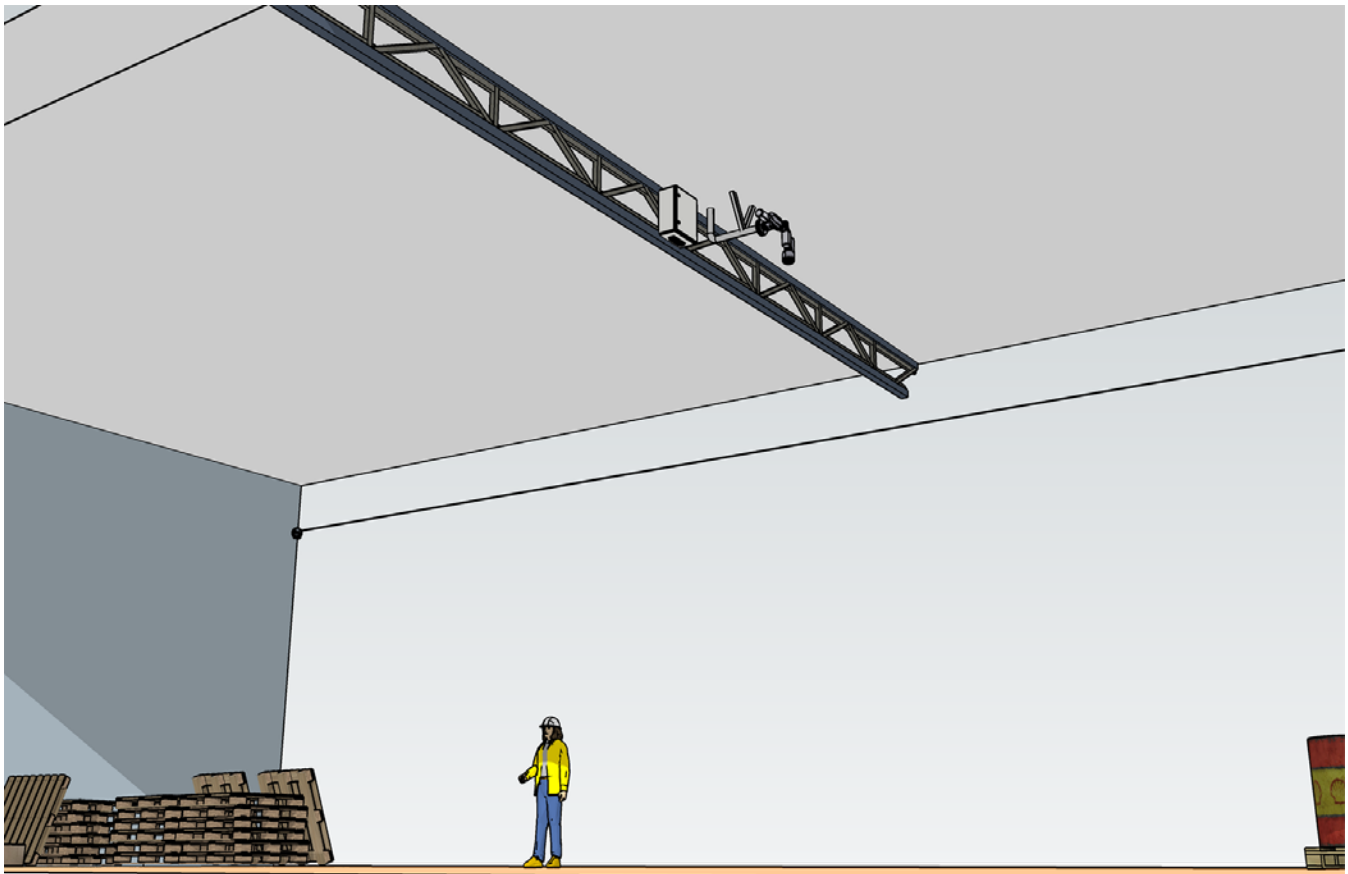
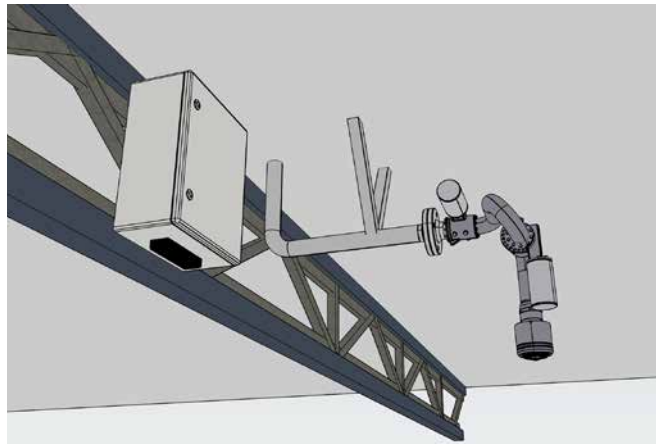

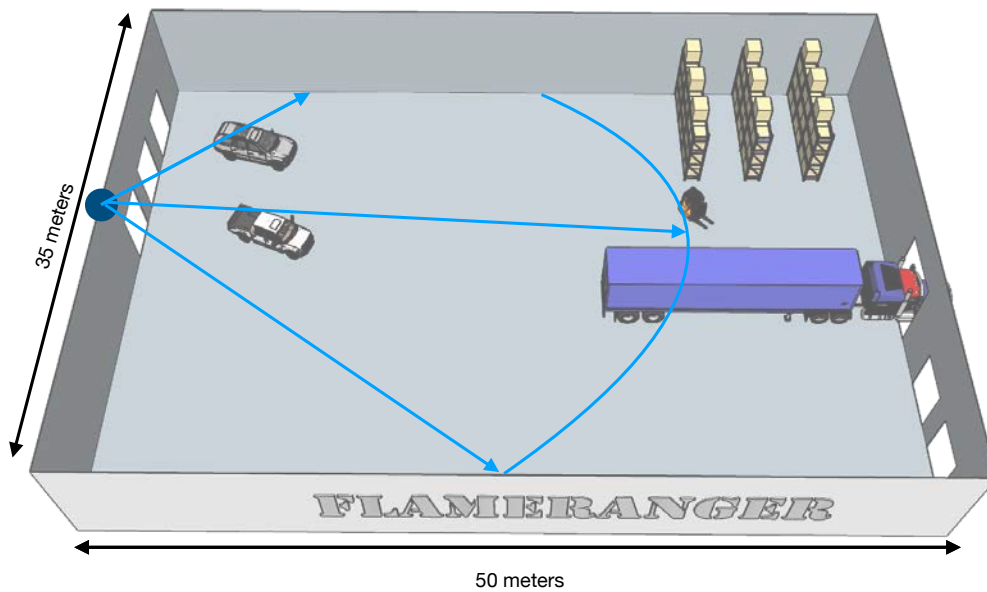

Installation on the wall

Usually provides easier access, thus it makes installation easier. The cover is limited to only 180° horizontal reach. An area of up to 40 m radius is protected. Installing on a wall provides a geometry suited for manual Joystick control.

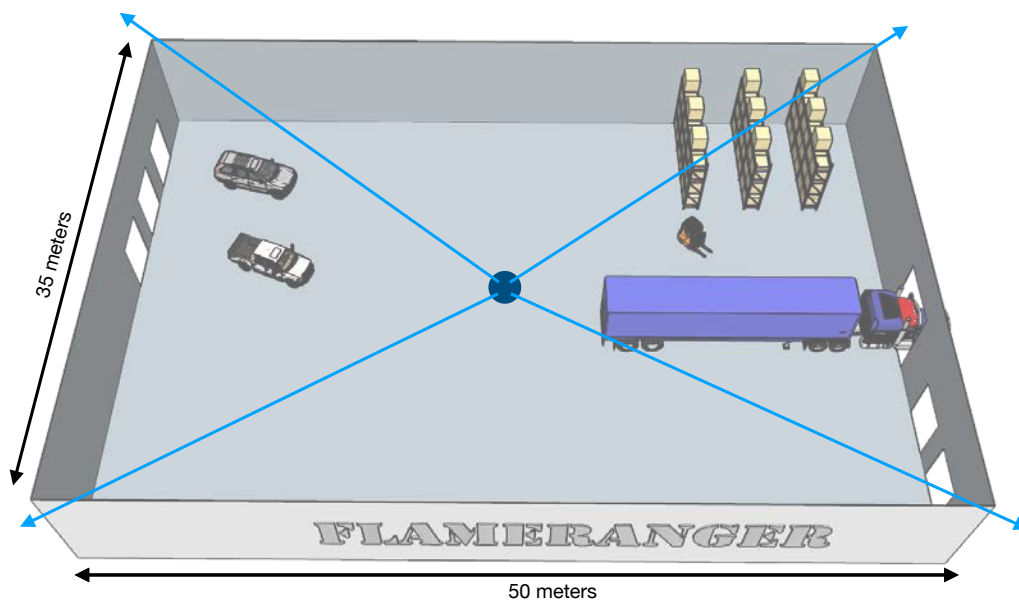

Installation hanging from the ceiling

Is recommended for fully automatic systems. It usually will provide better reach, the stream is less obstructed by objects on the floor. Up to 40 m reach provide a full 80 meter Ø cover. It is however difficult to control with a manual Joystick, because the geometry is rotated 90°, with the Nozzle facing straight down in default position.



FLOW SETTINGS

Nozzle Flow Setting

The Nozzle flow can easily be selected by fitting the appropriate flow shim.

The shim is custom manufactured (3D printed) to fit each order.

Please specify your required flow at your system pressure when ordering.

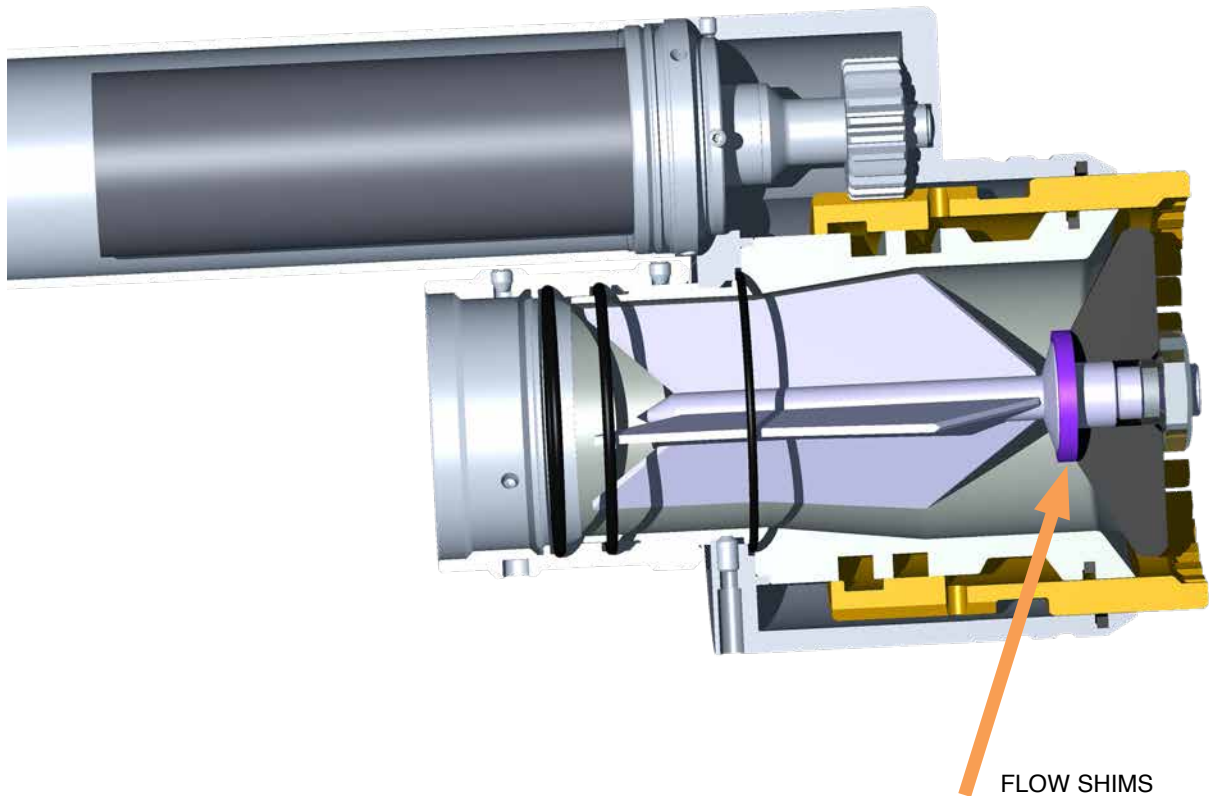

Flow shims are 3D printed specifically to order.

Typically in dimension (thickness) 0,8-6,2 mm

See flow and reach charts on the following pages



Reach chart

FORCE 50 with INTEG 50
Max reach at 35° discharge angle

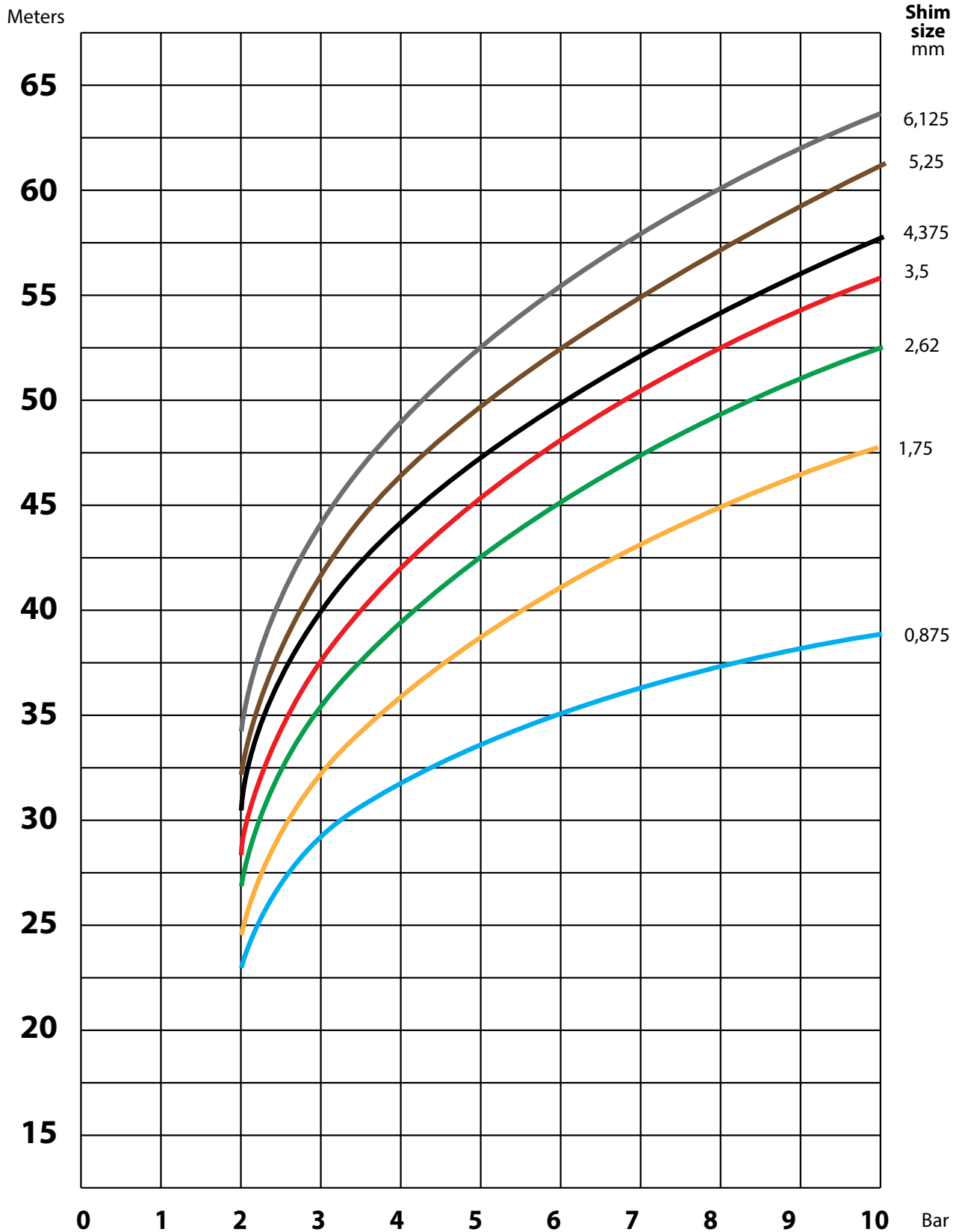

Flow chart

FORCE 50 with INTEG 50 Flow with various flow shims

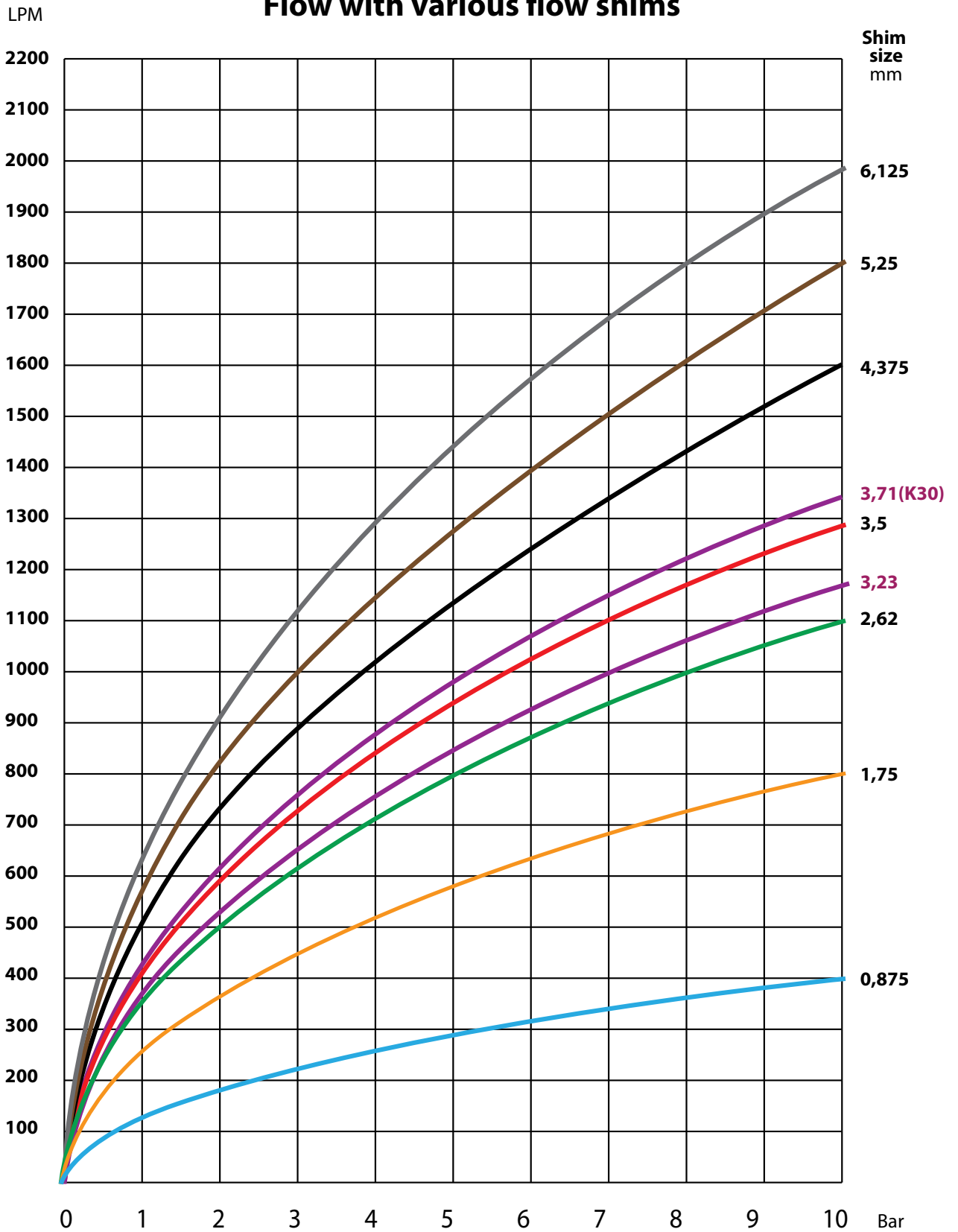

MECHANICAL INSTALLATION

Installing the detectors and the Robotic Nozzles

Installing The Robotic Nozzle

By now we assume you have decided if the Robotic Nozzle is to be installed on the wall, or hanging from the ceiling.

The FORCE 50 Robotic Nozzle is fitted with a DN50/PN16 flange (or similar size 2" ANSI flange or JIS flange).

! WARNING

The maximum reaction force at 2000 lit/min and 10 bar is 1400 N. The mounting pipe and bracket must withstand minimum 8 000 N of Force, to provide a safe and stable base.

The flange itself provides the required support to hold the FORCE 50. Additional support and brackets must be applied to the feeding pipe to keep it stable under operation. This is especially important during fully automatic operation. Use suitable M16 bolts and a flat seal to install the flange.

! CAUTION

Clearance!!

Take special precaution to ensure the Robotic Nozzle can move and rotate freely +/- 90° in all directions

Make sure there are no obstructions with 600 mm from the centre of rotation



The FORCE 50 weighs 19 Kg incl flange and nozzle

CEILING

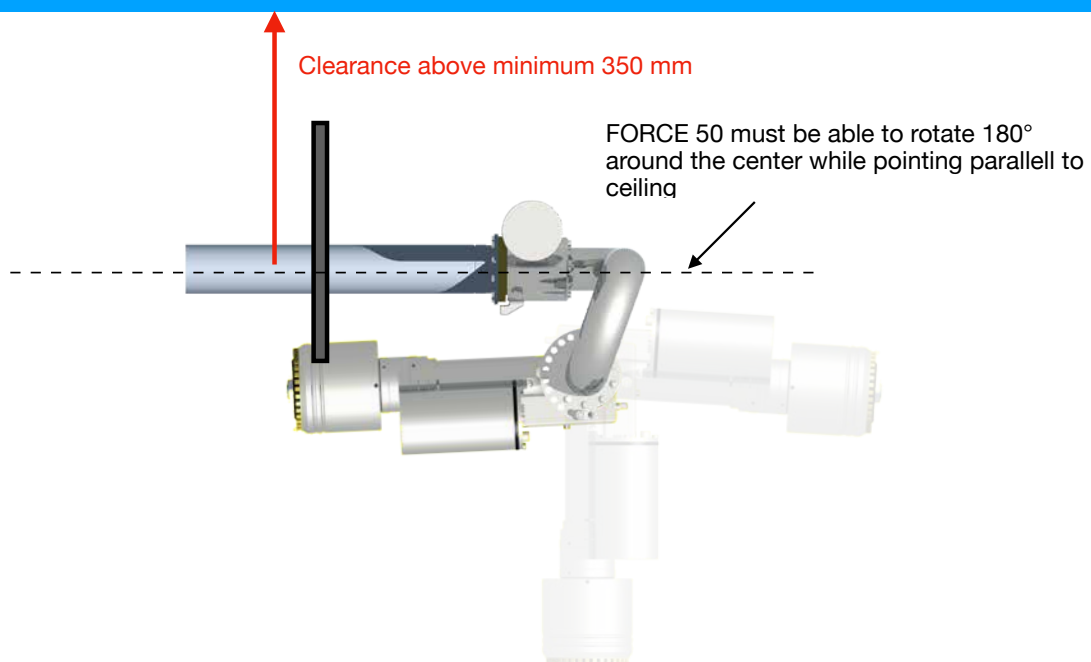

**MECHANICAL INSTALLATION
FLAMERANGER**

REV. 2.1 2021-11-07
3-3

*UNIFIRE FLAMERANGER
Autonomous Fire Suppression System*

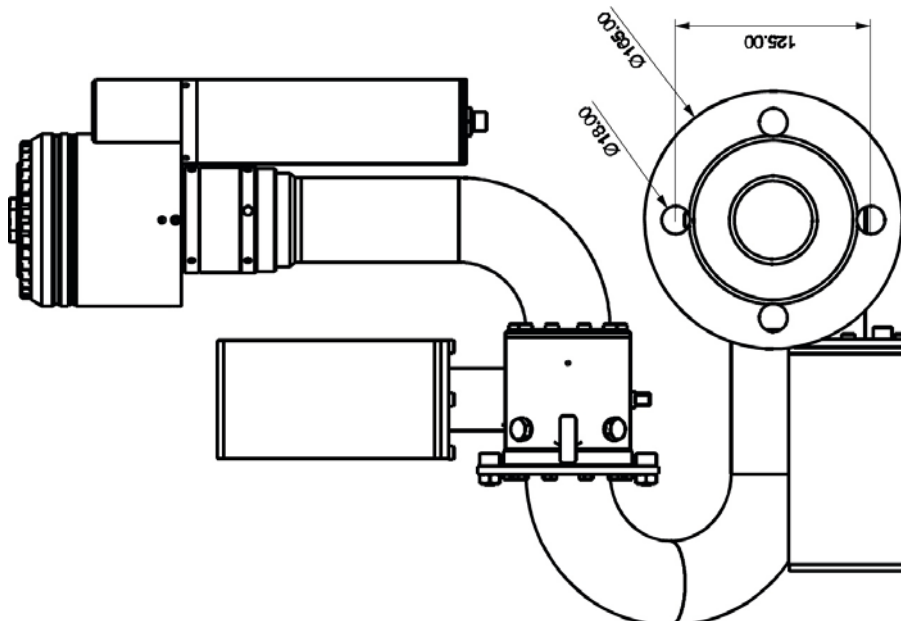
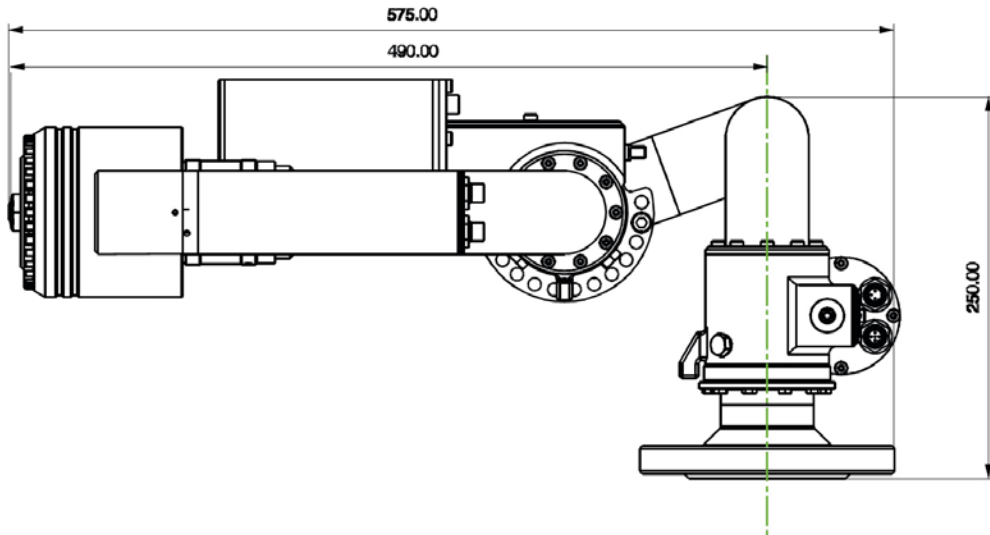
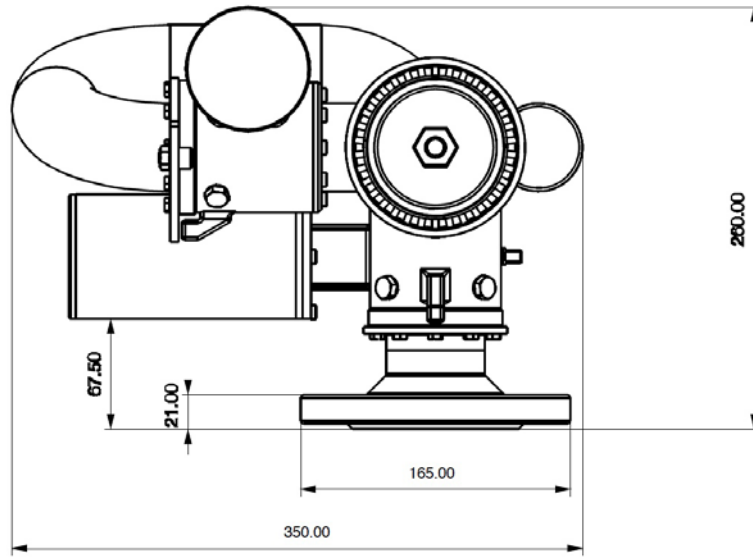

**MECHANICAL INSTALLATION
FLAMERANGER**

REV. 2.1 2021-11-07

3-4

UNIFIRE FLAMERANGER
Autonomous Fire Suppression System

Installing the FV300 detectors

Please reference the separate instruction for installing the FV300 detector brackets.

UNIFIRE has designed brackets that have been CNC precision machined to provide exactly the required angles of 45° inward and 5° down.

The brackets are delivered with laser pointer and holders to provide for relatively simple installation to achieve perfect alignment without the need for complex measuring.

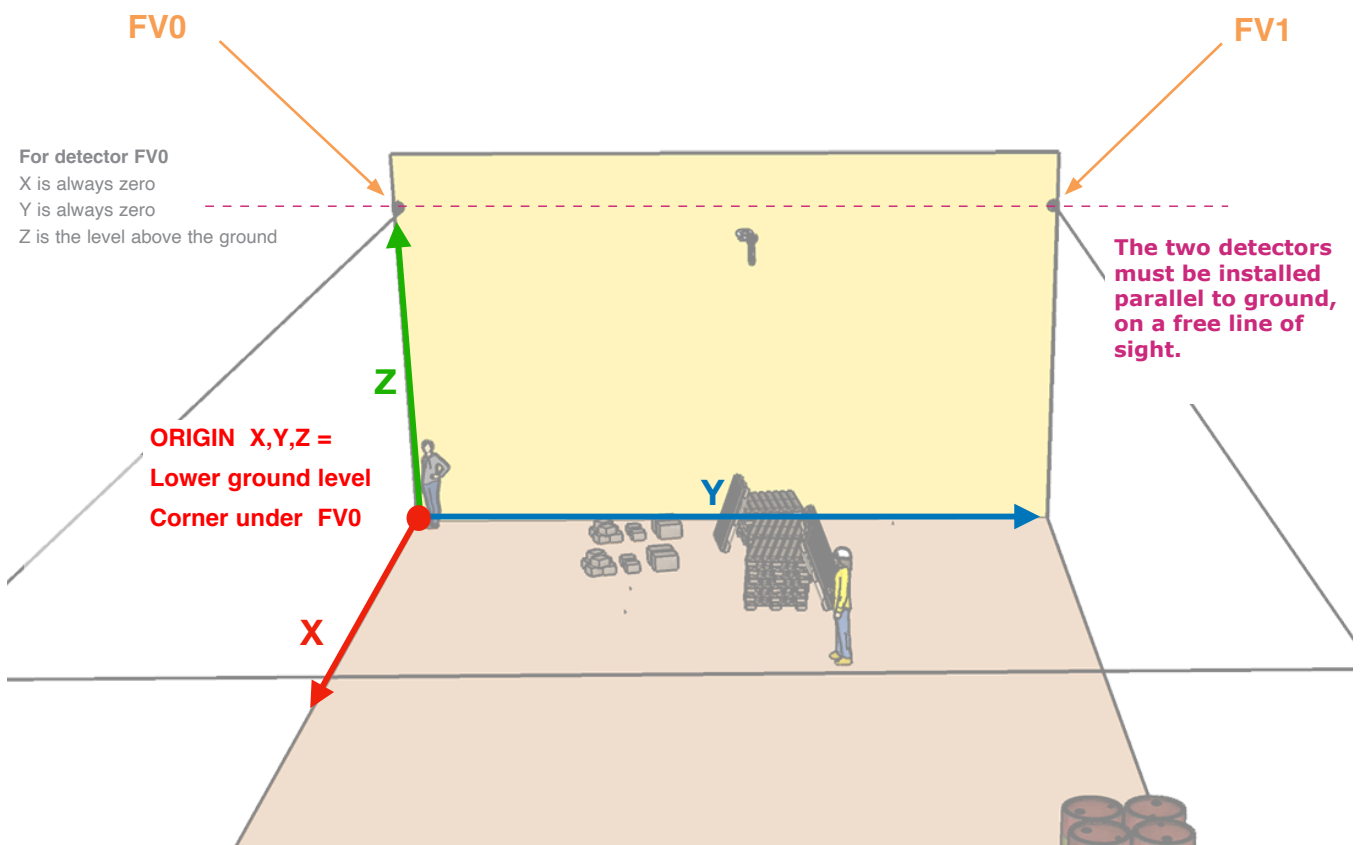
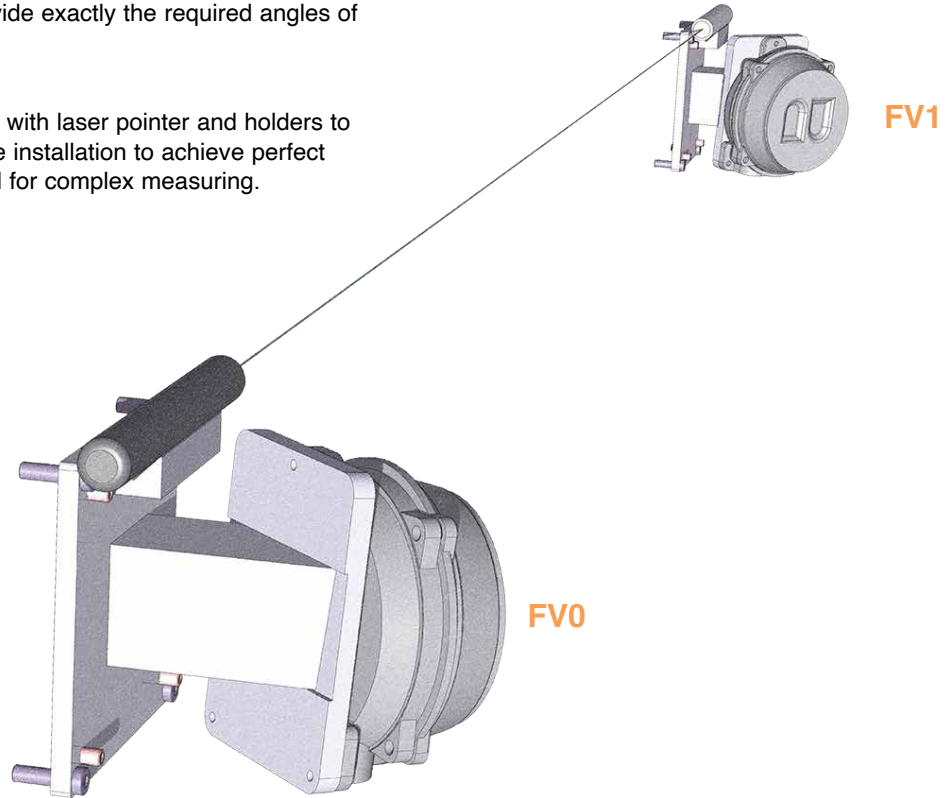

ELECTRICAL INSTALLATION

**Connecting the detectors and Robotic Nozzle
with the FLAMERANGER PLC.**

**Connecting the PLC to the Joystick, Valve
and TCP/IP Network**

Electrical installation FLAMERANGER system overview:

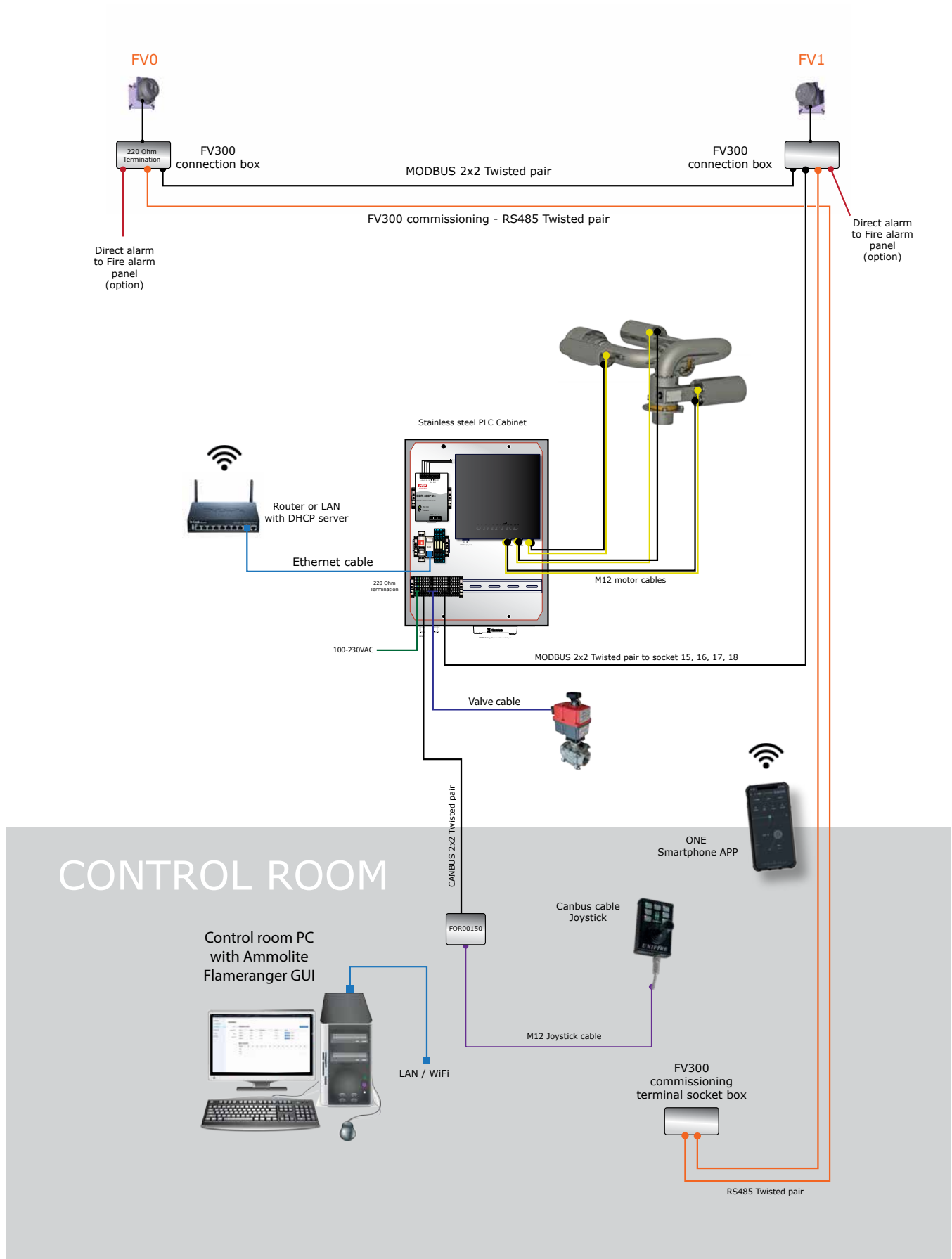

FV300 electrical connections

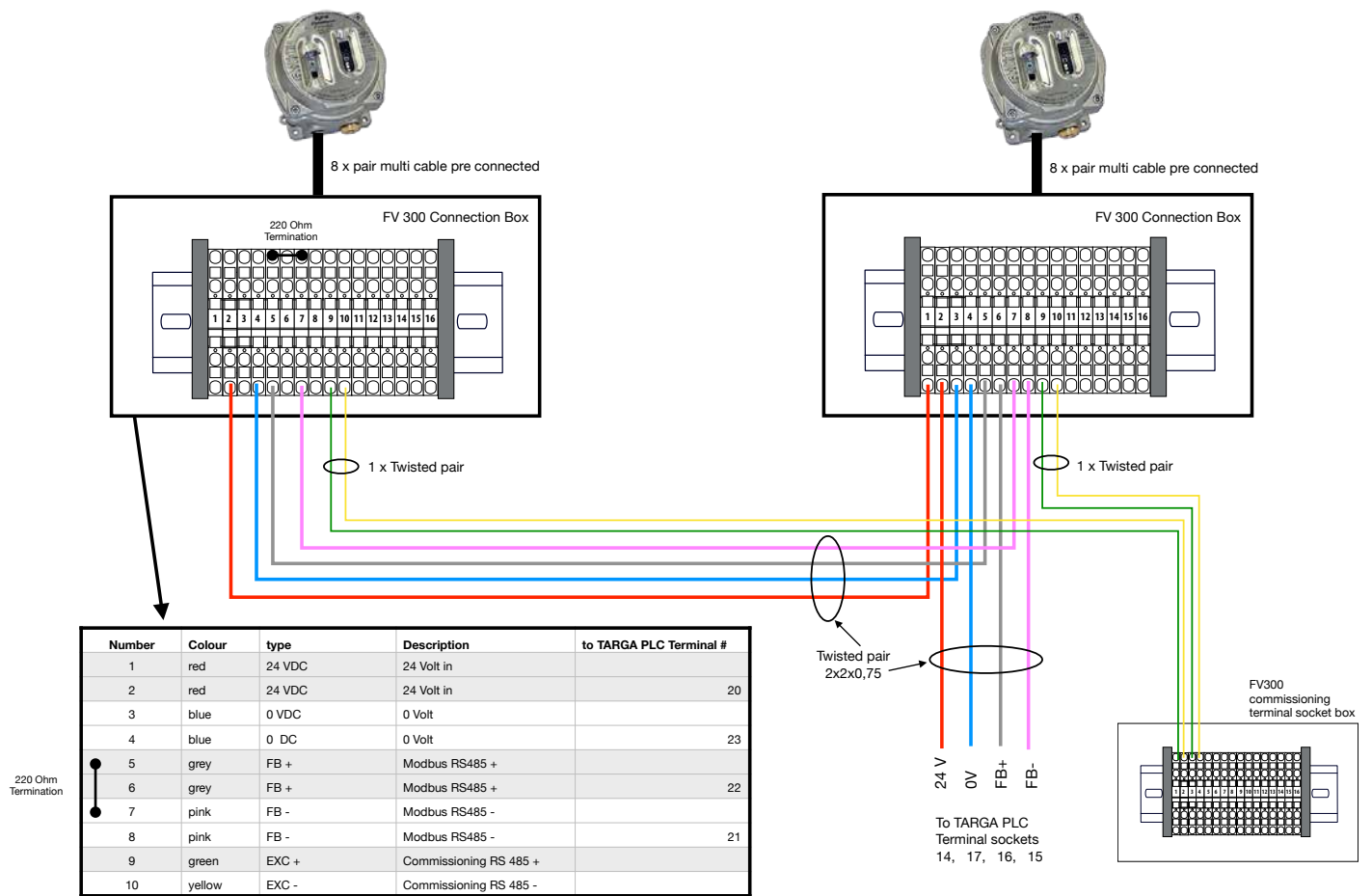

FV300 connection box terminal socket specifications

FV300 connection box terminal spec

Number	Colour	type	Description
1	red	24 VDC	24 Volt in
2		24 VDC	24 Volt in
3	blue	0 VDC	0 Volt
4		0 DC	0 Volt
5	grey	FB +	Modbus RS485 +
6		FB +	Modbus RS485 +
7	pink	FB -	Modbus RS485 -
8		FB -	Modbus RS485 -
9	green	EXC +	Commissioning RS 485 +
10	yellow	EXC -	Commissioning RS 485 -
11	brown	WT	Walk Test
12	white	0 VDC	0 Volt
13	grey/pink	FLT	Falut
14	blue/red	FLT C	Fault (fault = closes to 13)
15	black	ALM	Alarm
16	violet	ALM C	Alarm (alarm = closes to 15)

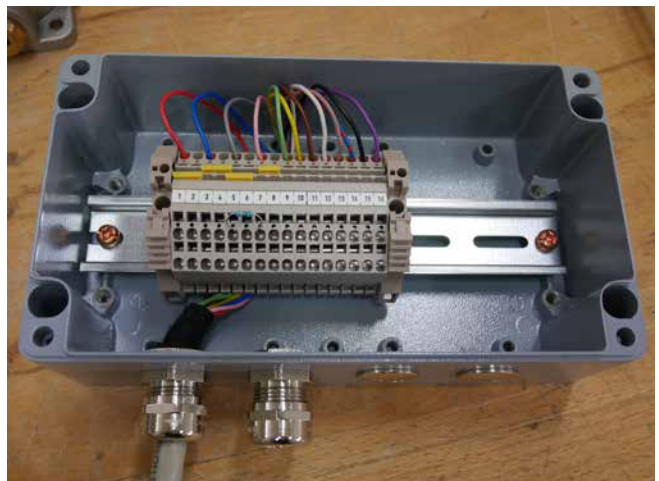

FV300 generic wiring by TYCO

* IT IS RECOMMENDED THAT AN RS485 CONNECTION IS PROVIDED TO CONNECT TO A PC FOR REMOTE CONFIGURATION AND DIAGNOSTICS

CONFIGURATION/
DIAGNOSTICS
ACCESS*

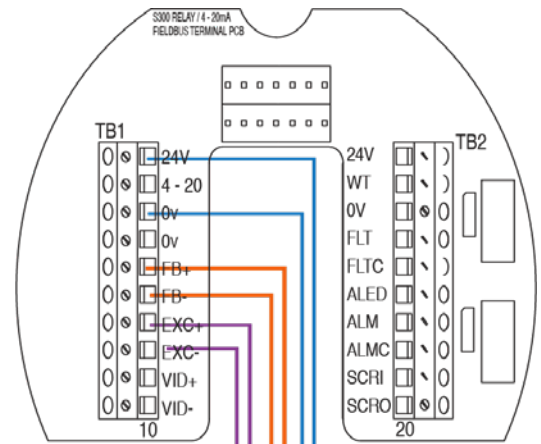

PLC terminal sockets:

- 15 FB-
- 16 FB+
- 17 GND
- 14 +24V

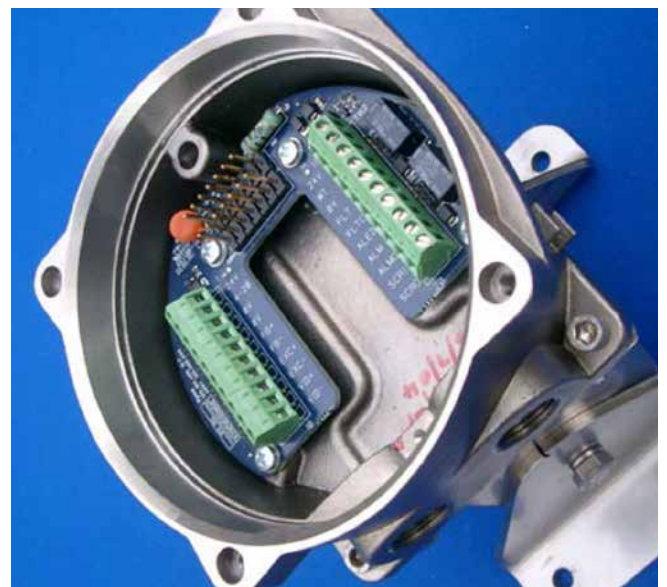

Wiring the detectors

! CAUTION

A qualified technician must carry out electrical installation according to IEC regulations and any other requirements of the authority having jurisdiction.

Main Power

The FV300 flame detectors require uninterrupted power. In the event of a power failure, an interrupted power supply may result in the detectors failing to operate.

Selecting Cables

The cables selected for the interconnection to the control equipment shall meet the requirements of any national codes and the requirements of the local AHJ. Cables should not normally have a cross sectional area of less than 1 mm² for solid conductors or 0.5 mm² for stranded conductors. The cable temperature rating must allow for an increase in the enclosure temperature of 25 °C (77 °F) above ambient. Refer to the *FV300 FLAMEVision* user manual for a list of recommended cables.

Cable Entry Sealing (Gland Connectors)

! CAUTION

Cable glands and stopping plugs must be suitably sealed to prevent the ingress of moisture.

- Only cable glands incorporating an inner cable seal shall be used. In exposed outdoor areas, fitting a shroud over the cable glands is considered best practice.
- Seal the cable glands to the detector housing.
- In applications where the ambient temperature is expected to be 40 °C (104 °F) or higher, use cable glands with a silicon inner seal. When fitted, the shroud must be made of CR rubber. Stopping plugs with a mushroom head and integral o-ring should be used. The glands or stopping plugs should be hand-tightened with the addition of at least a further quarter turn applied by a spanner or other suitable tool.
- When looking at the face of the detector, the right gland hole should be used to connect to the PLC. The left gland hole should be used for the detector configuration process.



INSTALLATION CABLE TO THE DETECTORS

Use Modbus (RS485) installation cable. Typically 2x2x 0,75mm² twisted pair.

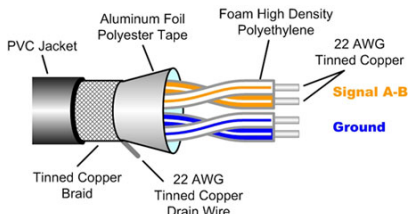

Figure 4. Industrial RS-485 Cable: Belden 3107A

Connect the wires in the connection boxes to the terminal sockets, marked correspondingly to the terminal sockets in the PLC cabinet.

Pair (power 14+17) and (signal 15+16)

14	24V	FV300 24V
15	RS485	FV300 FB-
16	RS485	FV300 FB+
17	GND	FV300 0V

THE FLAMERANGER PLC CABINET

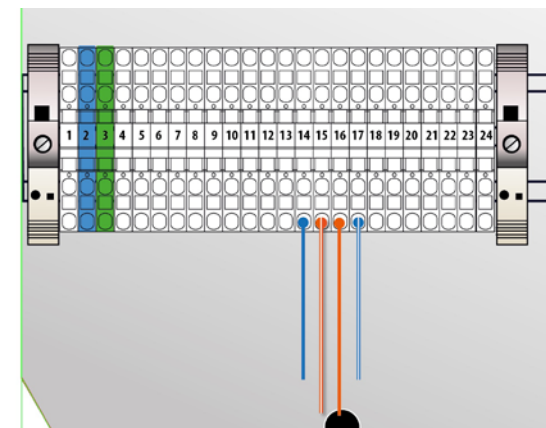

* IT IS RECOMMENDED THAT AN RS485 CONNECTION IS PROVIDED TO CONNECT TO A PC FOR REMOTE CONFIGURATION AND DIAGNOSTICS

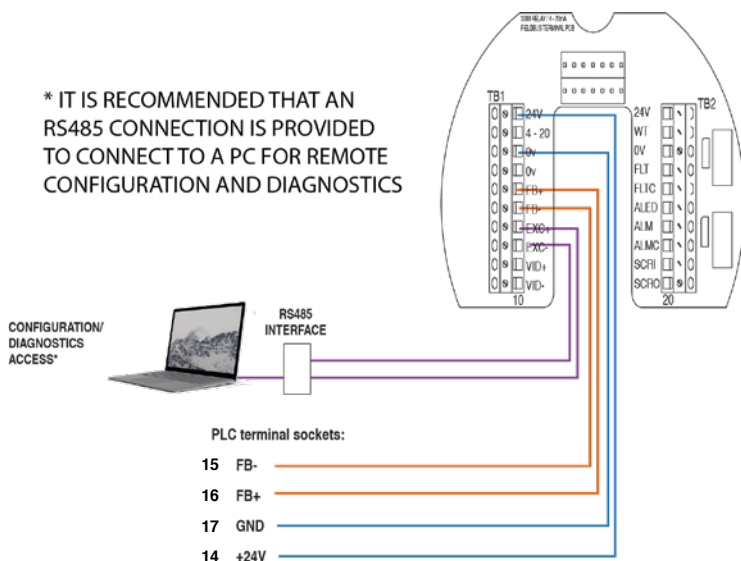

ELECTRICAL INSTALLATION

Generic TARGA PLC overview

The TARGA Robotic Nozzle PLC is a highly capable programmable PLC. With support for up to 6 x BLDC drivers

Communication Protocols: 2 x CAN 2.0 29-bit header (UniCAN) 125,250,500 kB/s, RS232, RS485 (Modbus, DMX, etc.)

Physical Layer Protocols: USB, Ethernet (TCP/IP, web socket), others available per customer requirements

6 BLDC Motor Driver Card Slots (optional: slots for DO or DI/AI expansion cards)

Inputs: 4 digital inputs (NPN) + 2 per installed motor driver card, 6 analogue inputs (4-20 mA or 0-5V), expandable & customizable to customer requirements

Outputs: 8 digital outputs, of which 4 can be set to PWM.

Below is a generic example of what a TARGA PLC system can look like.

A DHCP Router is required to set up the system with the Ammolite GUI. This will also allow for the ONE App to be activated

Over the web interface the systems can be remote controlled and remotely configured and monitored. From anywhere in the world.

A cabled Canbus Joystick can be connected for local control.

An industrial radio remote control (Hetricon ERGO-S) can also be locally connected.

Digital and analogue outputs are generic and can be used to operate valves, and send or receive status signals.

TARGA PLC generic system overview

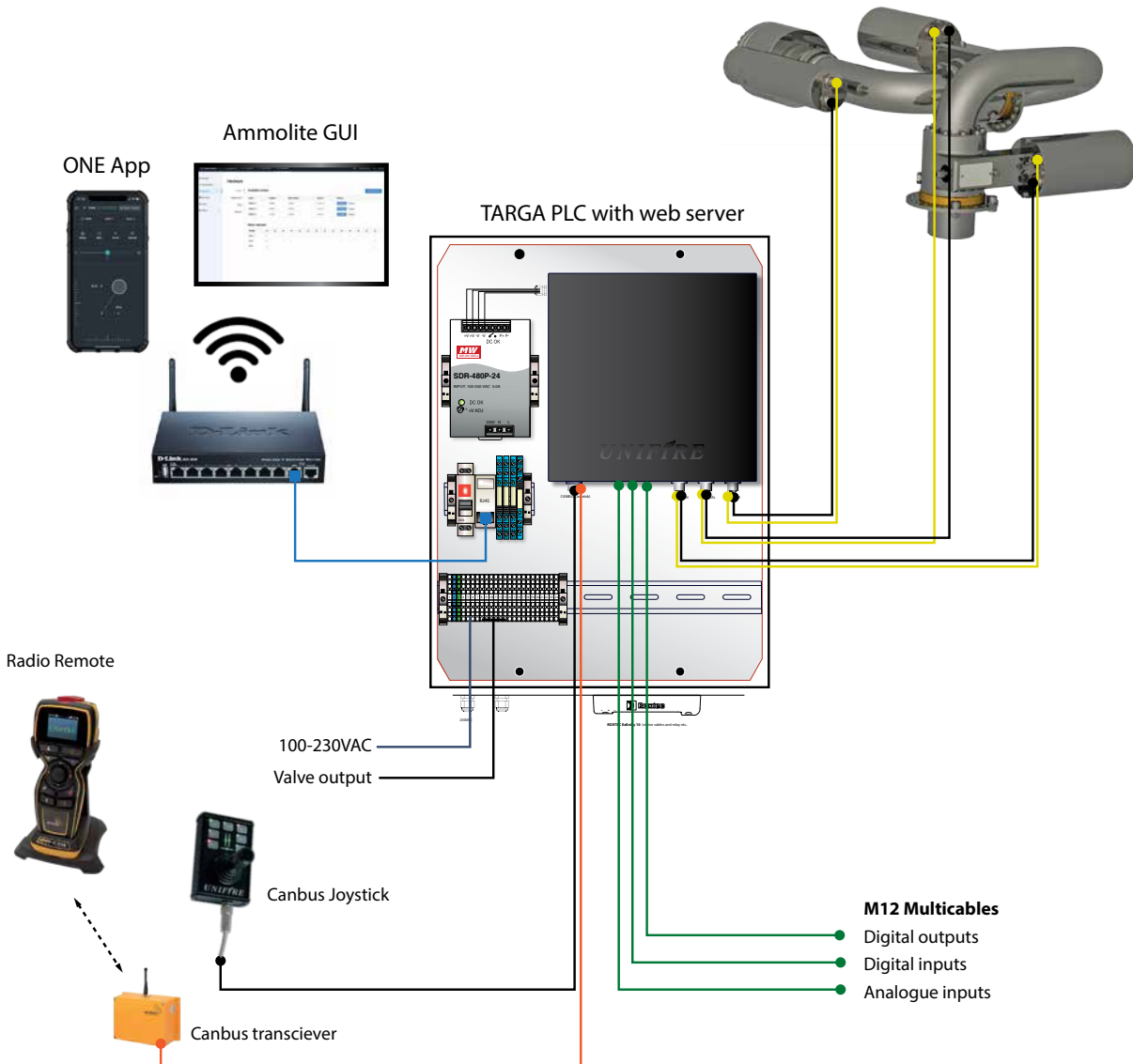

TARGA PLC generic M12 pin-specification

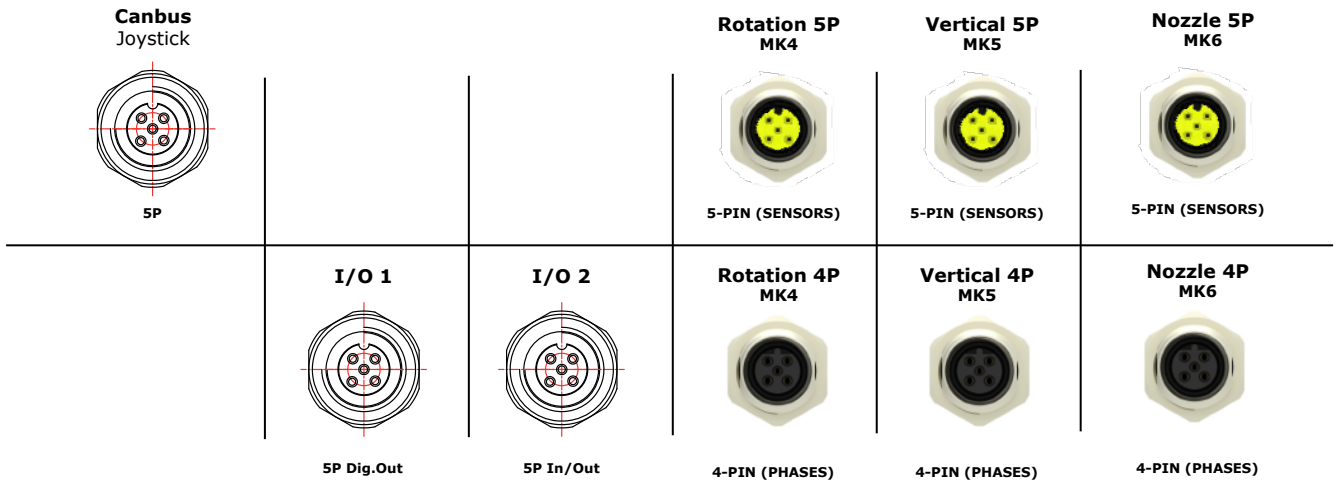

5-PIN A-coded (sensors)

- 1 - BROWN
- 2 - WHITE
- 3 - BLUE
- 4 - BLACK
- 5 - GREY

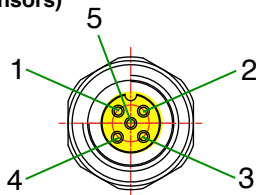

Joystick 5P Canbus		BLDC sensors M12 A-coded 5-pin Rotation / Vertical / Nozzle	
P1	Shield	P1	GND
P2	24 VDC	P2	5 VDC
P3	GND	P3	HALL 3
P4	CAN H	P4	HALL 2
P5	CAN L	P5	HALL 1

4-PIN B-coded (phases)

- 1 - BROWN
- 2 - n/a
- 3 - BLUE
- 4 - BLACK
- 5 - n/a

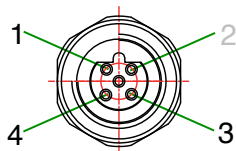

M12 5, 8 or 12-pin Dig In/Out		BLDC phases M12 B-coded 4-pin Rotation / Vertical / Nozzle	
P1	generic	P1	PHASE 1
P2	generic	P2	not connected
P3	generic	P3	PHASE 2
P4	generic	P4	PHASE 3
P5	generic	P5	not connected

**ELECTRICAL INSTALLATION
FLAMERANGER**

REV. 2.1 2021-11-07
4-10

*UNIFIRE FLAMERANGER
Autonomous Fire Suppression System*

Connecting the FORCE 50 to the TARGA PLC

The FORCE 50 system is fitted with M12 multi connector.
The standard system is delivered with 5-meter M12 cables

Connect the 6 x 5 meter M12 cables from the PLC to the
Robotic Nozzle

From left to right: Rotation, Vertical, Nozzle

Yellow A-coded connectors are for the BLDC Motor Sensors
.

Black B-coded connectors are for the BLDC Motor Phases.

The key-coding makes it impossible to accidentally cross
the cables.



Cables to Vertical (MK5)

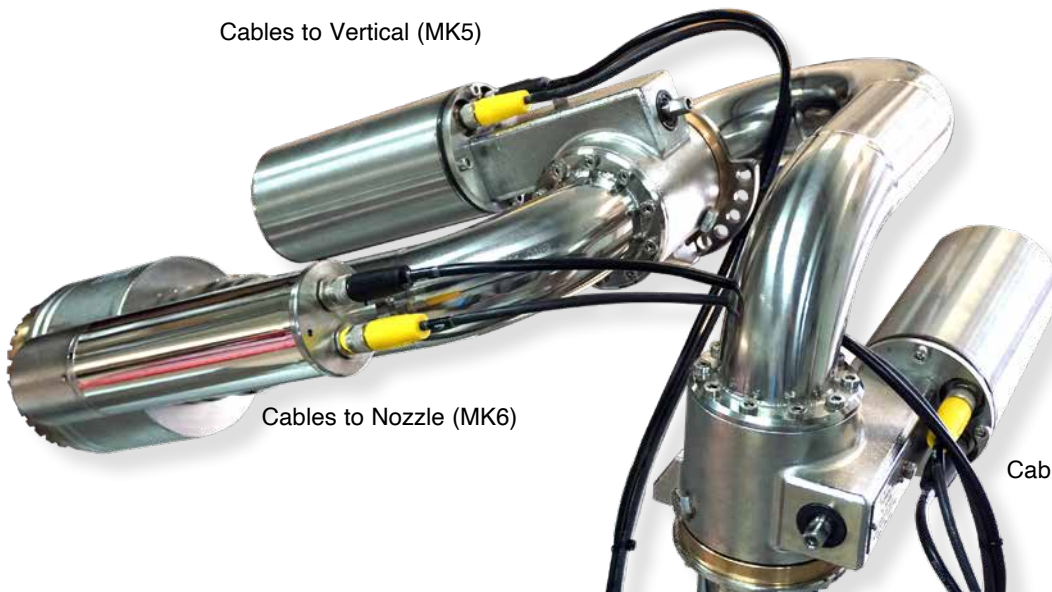

Cables to Nozzle (MK6)

Cables to Rotation (MK4)



Phases and Sensor cable to vertical motor



Monitor and Nozzle connected. Ceiling hanging orientation

**ELECTRICAL INSTALLATION
FLAMERANGER**

REV. 2.1 2021-11-07
4-12

UNIFIRE FLAMERANGER
Autonomous Fire Suppression System

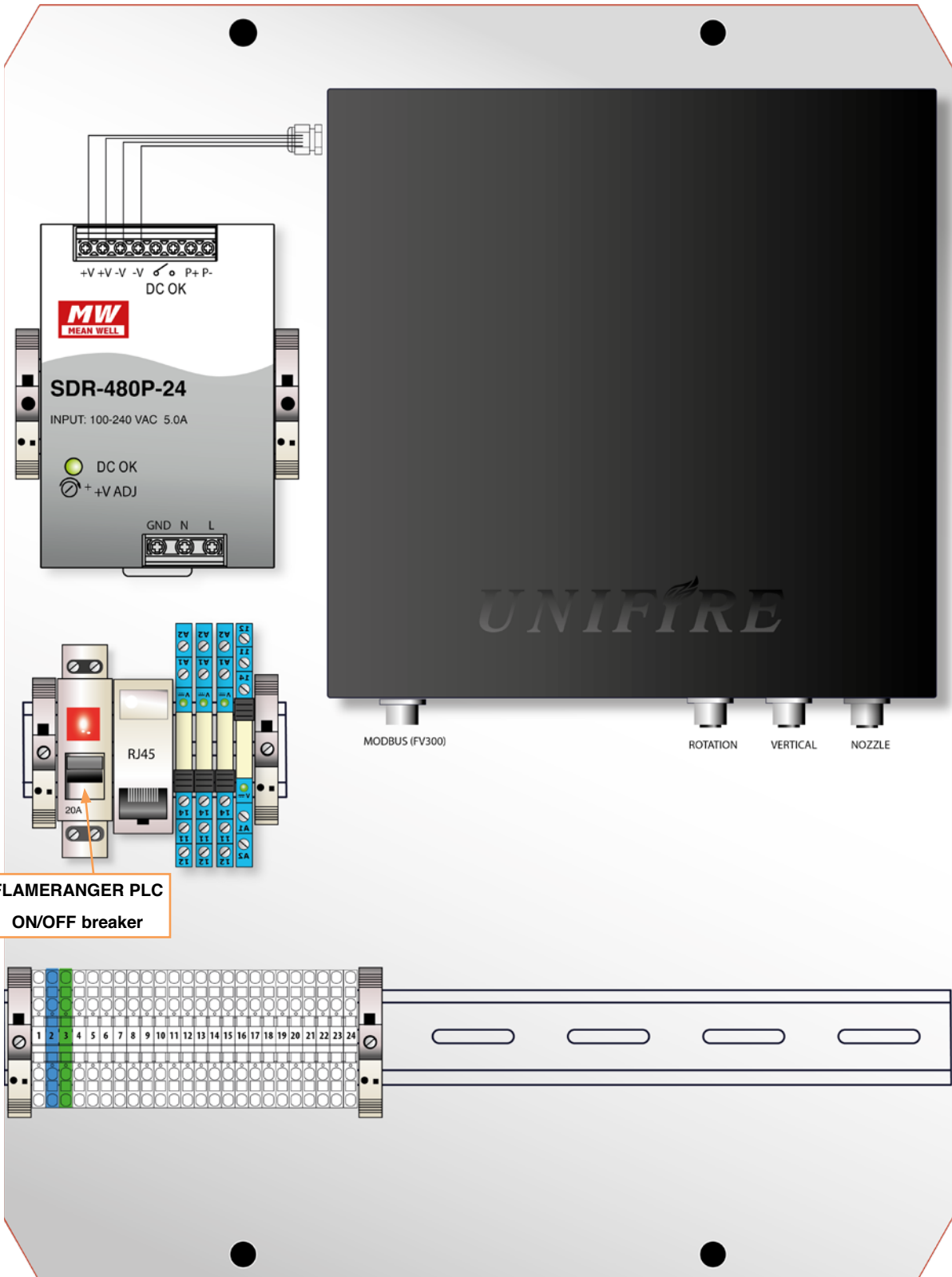

**FLAMERANGER PLC
ON/OFF breaker**

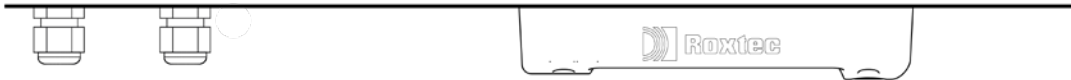

FLAMERANGER PLC terminal socket specifications



Terminal	Function	Internal connection	External connection	Function	Cable	Cable dim.	M12 Color
1	PSU	Power	L	Power	1	1,5 mm ²	
2	PSU	Power	N	Power	2	1,5 mm ²	
3	PSU	Power	GND	Power	3	1,5 mm ²	
4	CAN H	Main board	Joystick connection box	CAN	Black	0,5 mm ²	Black
5	CAN L	Main board	Joystick connection box	CAN	Grey	0,5 mm ²	Grey
6	(CAN) GND	Main board	Joystick connection box	CAN	Blue	0,5 mm ²	Blue
7	(CAN) VCC	Main board	Joystick connection box	CAN	White	0,5 mm ²	White
8	NC	Relay 1	Valve	Relay	8	0,5 mm ²	
9	COM	Relay 1	Valve	Relay	9	0,5 mm ²	
10	NO	Relay 1	Valve	Relay	10	0,5 mm ²	
11	NC	Relay 2	Valve	Relay	11	0,5 mm ²	
12	COM	Relay 2	Valve	Relay	12	0,5 mm ²	
13	NO	Relay 2	Valve	Relay	13	0,5 mm ²	
14	VCC	Main board	FV300 Flame Detector	Power +	14	0,5 mm ²	
15	B-	Main board	FV300 Flame Detector	Data	15	0,5 mm ²	
16	A+	Main board	FV300 Flame Detector	Data	16	0,5 mm ²	
17	GND	Main board	FV300 Flame Detector	Power -	17	0,5 mm ²	

**CALIBRATION AND SOFTWARE
FLAMERANGER**

REV. 2.1 2021-11-07
5-1

UNIFIRE FLAMERANGER
Autonomous Fire Suppression System

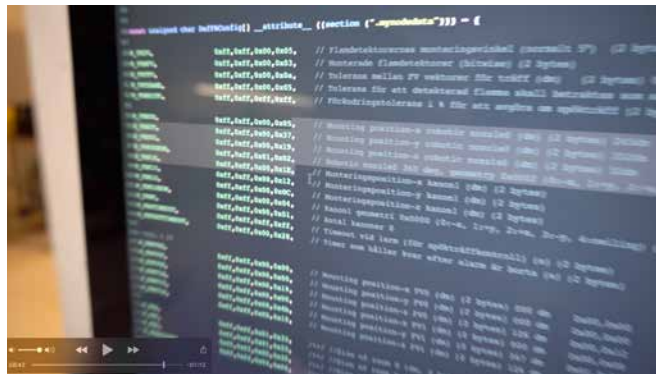
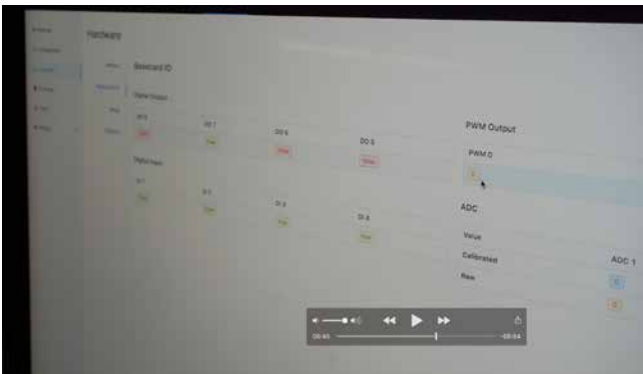
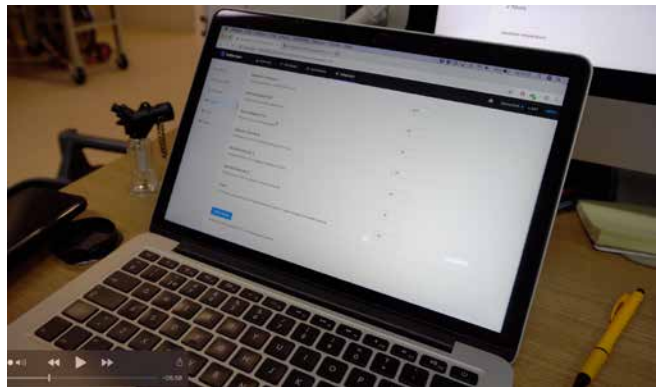
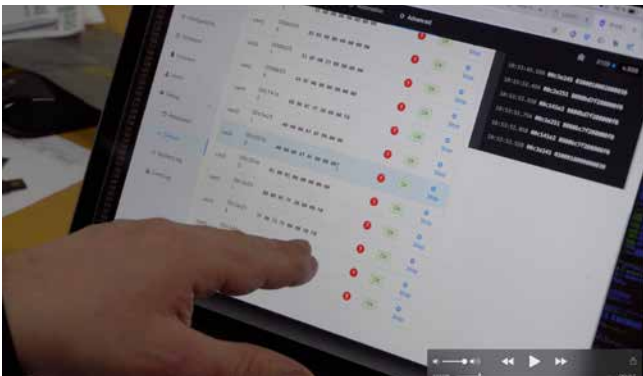

SOFTWARE SETUP

Setting up the system geometry

Calibrating motors operating range

FLAMERANGER Geometry Setup

After the electrical installation is completed, the installer must enter the position data and dimensions, which are required by the system to work properly. It is crucial the distances and positions are accurate.

We recommend that the dimensions and distances be verified by measuring from several positions and by at least two individuals that cross-check and verify the dimensions.

The system ORIGO is defined as the lower right corner of the volume protected. The protected volume is defined as distance from floor to the detectors (Z), distance between the detectors (Y), and (X) is limited by the reach of the water stream. The robotic nozzle can be installed freely, anywhere within the volume as limited by X-Y-Z axis.

For installation and setup we recommend the use of BOSCH GLM 120 C Professional laser range finder with camera as viewfinder.

This pocket-size device accurately provides distance and angle between the detectors and the robotic nozzle.



Please go through these steps to setup the system:

FIRST: Verify that the detectors are absolutely parallel and absolutely level to the ground.

(B and C will always have the same value what the system is installed correctly)

Then measure the distances in Decimeters (dm):

- A: Distance between detectors (Y)
- B: For right detector: Z Distance from floor
- C: For left detector: Z Distance from floor
- D: For Nozzle X distance from origo
- E: For Nozzle Y distance from origo
- F: For Nozzle Z distance from floor

G: last enter the time-out in seconds. This keeps the valve open for the specified number of seconds after the flames are no longer detected.

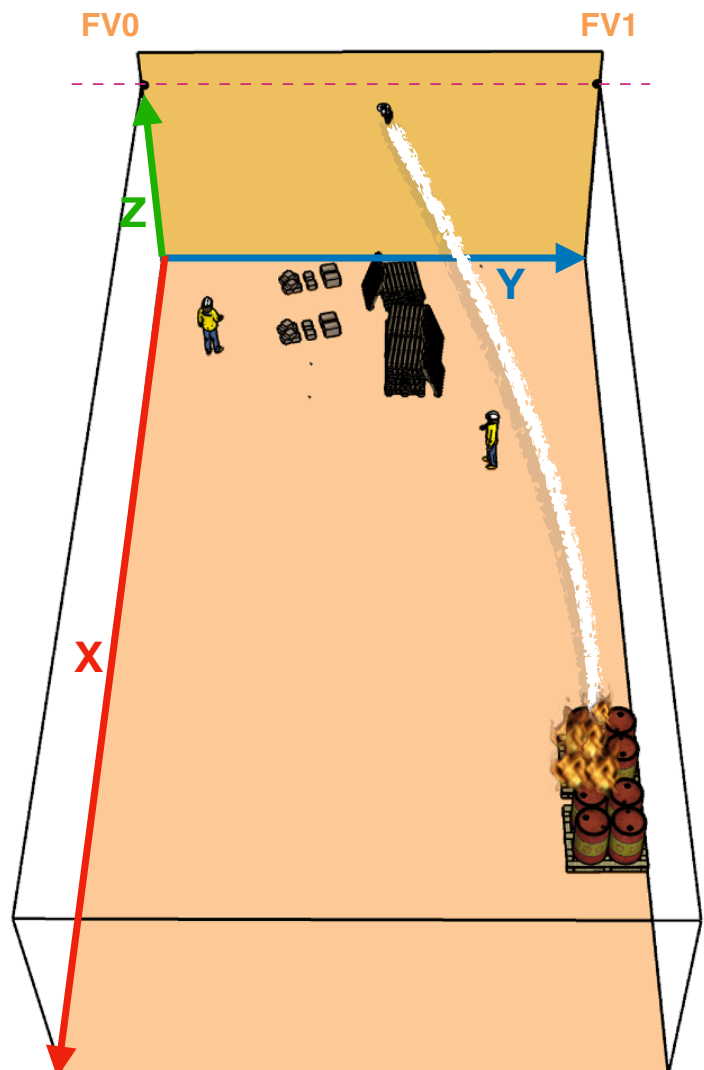

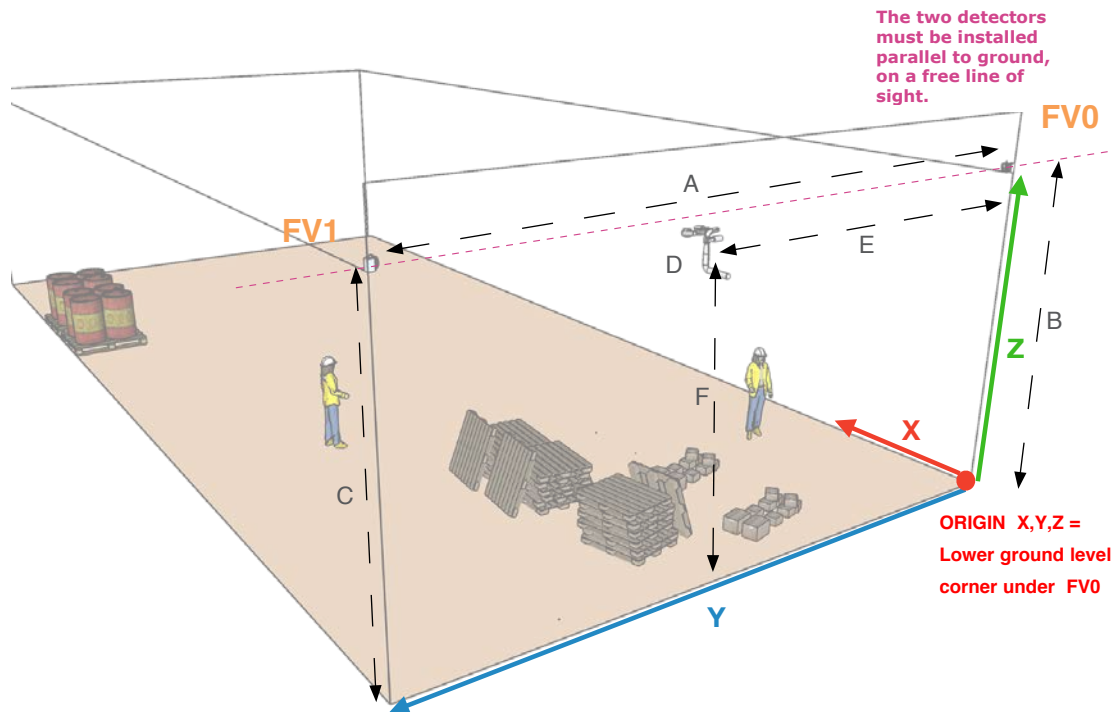

System Setup Example

We will use the FLAMERANGER hall above as an example.

The detectors are installed parallel to each other, and parallel to the ground. The distance between the detectors is (A)12 meters. The detectors are all (B and C) 5,8 meters from the floor

The monitor is (D) 0,5 meter form the wall, and (E) 4,3 meters inwards ,(F)5,3 meter from the floor.

Enter the distances in Decimeter (Dm):

A: Distance between detectors	120
B: For left detector: Z Distance from floor	58
C: For right detector: Z Distance from floor	58
D: For Monitor X distance	5
E: For Monitor Y distance	43
F: For Monitor Z distance from floor	53

Last we choose 20 seconds as our time out:

G: Time Out after fire out	20 seconds
----------------------------	------------

Connect a router the to the FLAMERANGER PLC, or connect the PLC to a network. Access the FLAMERANGER administration and setup tool TARGA/dash by entering the IP Address of the FLAMERANGER Web-server in your browser window. The IP address is dynamically generated by the PHP Server.

Log in to the TARGA/dash.

The user level "admin" can access the system setup parameters as described herein.

This brings you to the TARGA/dash overview.

Proceed by following these steps:

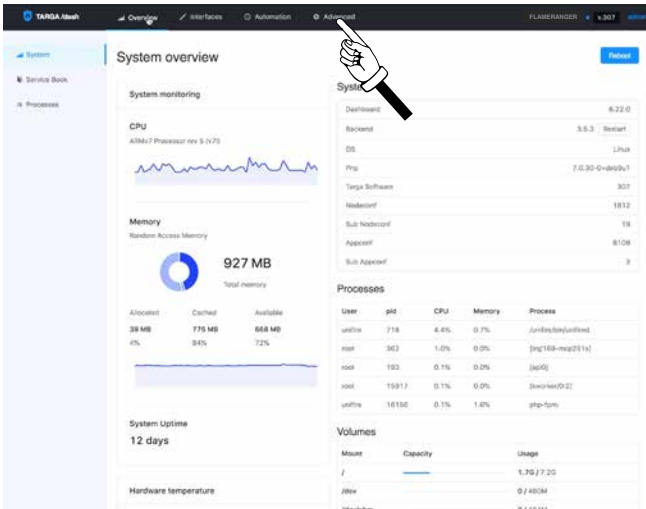

1. Click "Advanced"

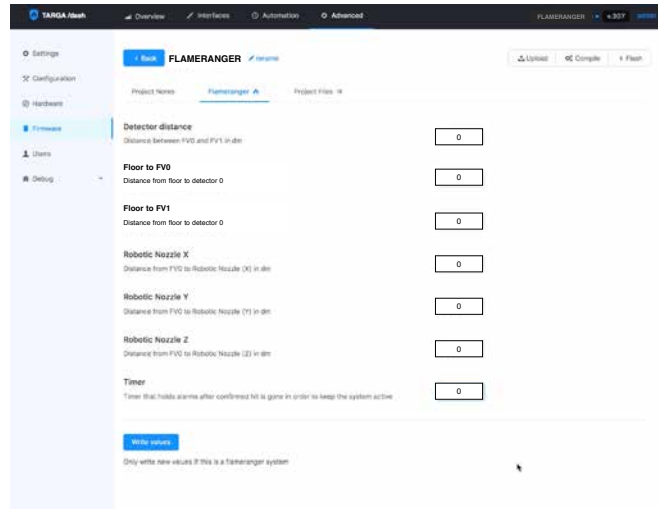

4. In our example, we enter the values for the FLAMERANGER hall as mentioned earlier.

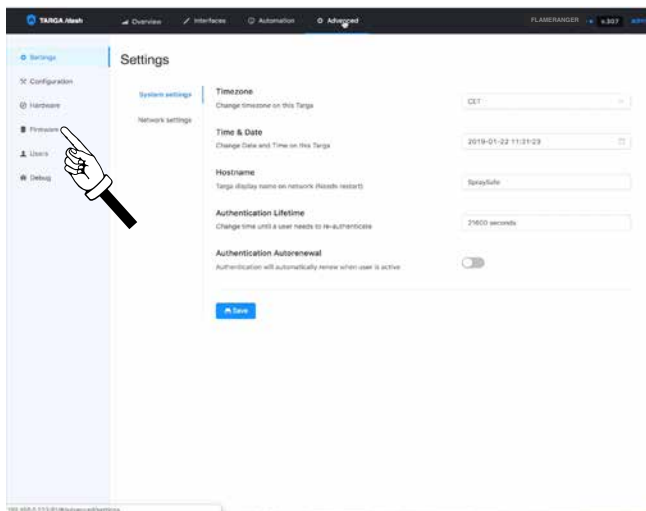

2. Click "Firmware"

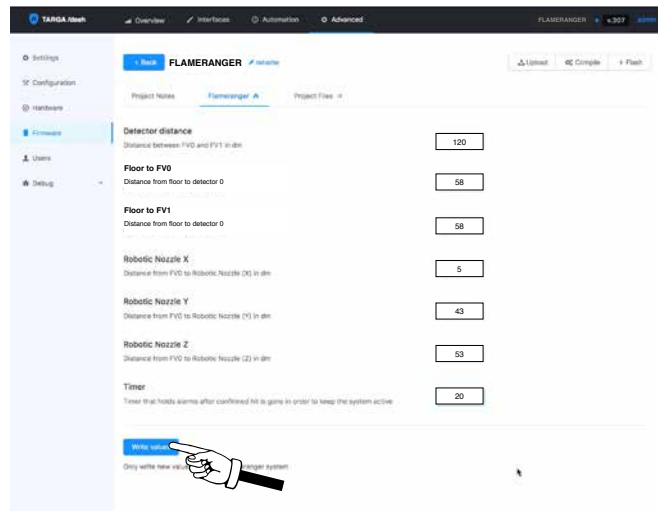

5. Click "Write values". (this generates the new code from the entered values)

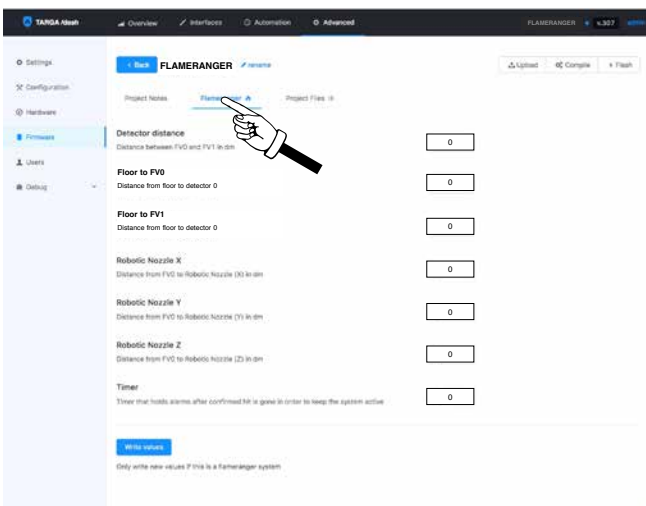

3. Click tab #Flameranger to open up the setup window for system geometry.

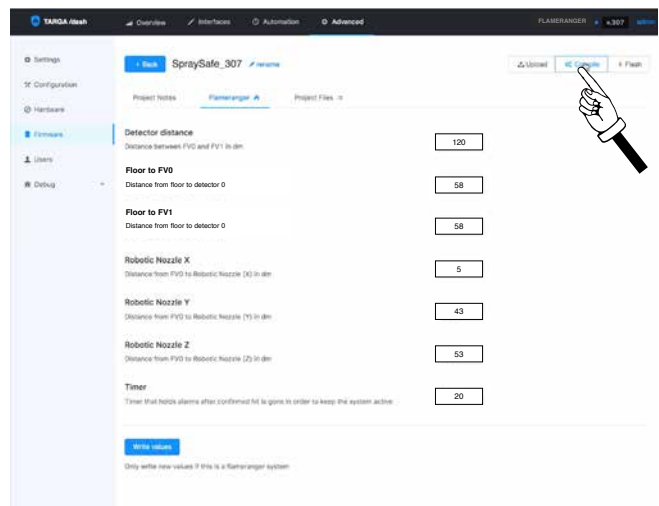

6 Click "Compile". (this compiles the new code to a format that the PLC can run)

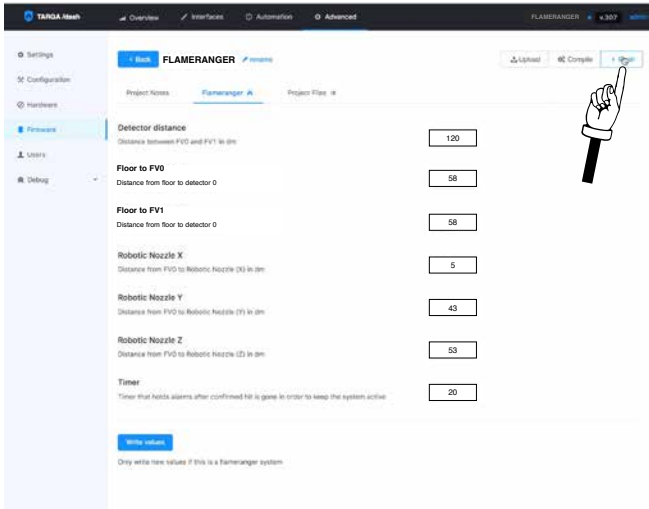

7. Click “Flash”, to upload the new code to the PLC.

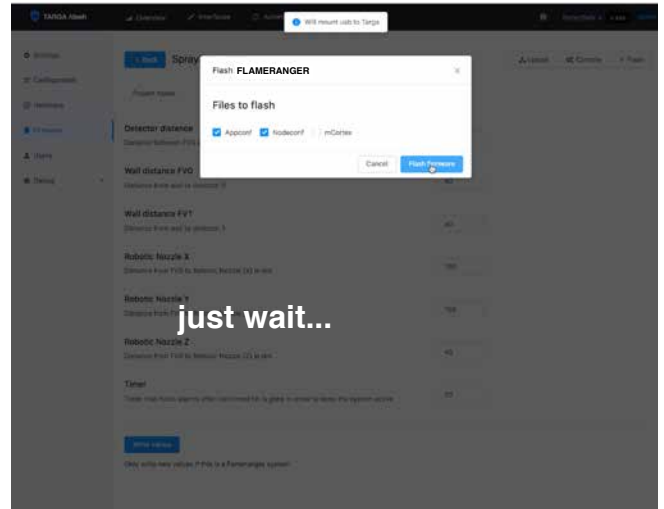

10. Reads “Will mount USB to TARGA”... this is the second step of the PLC reprogramming. May take up to 10 seconds.

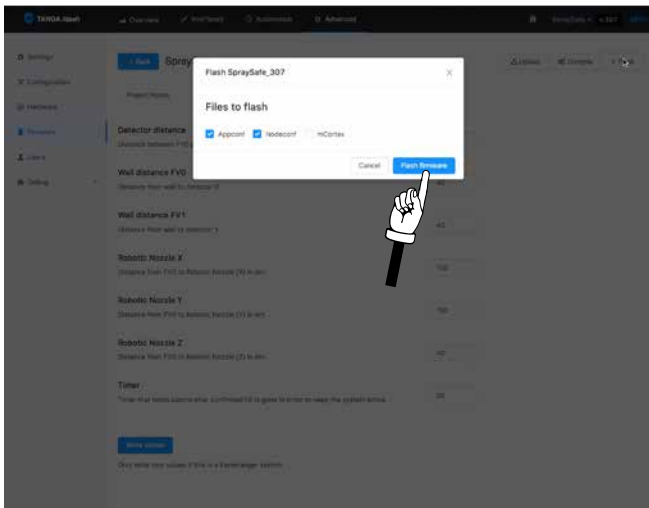

8. This opens a window that lets you choose which files to flash. Check Appconf and Nodeconf (default). Then click “Flash Firmware”.

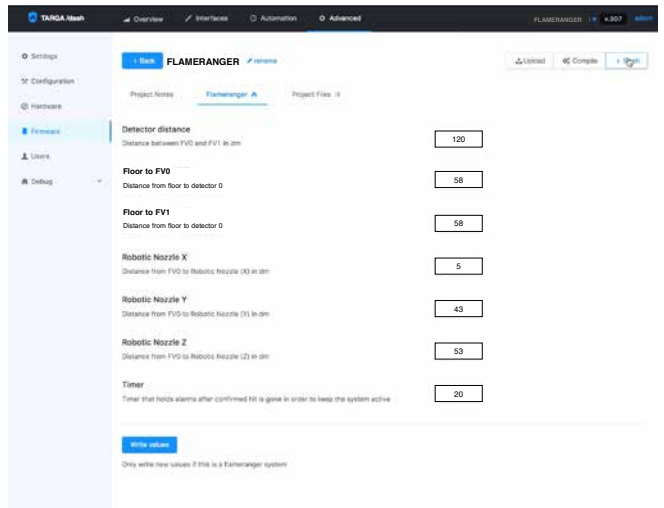

11. and we are done. The upper right corner will briefly read “v.xxx”. When this reads v.307, the system is ready.

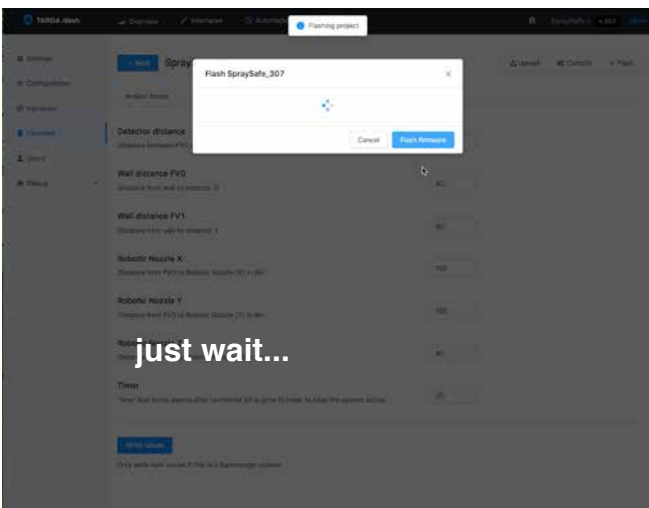

9. Reads “Flashing project”. This may take up to 10 seconds.

Calibrating the Robotic Nozzle's operating range

For the system to operate correctly, the movement range of the Robotic Nozzle must be calibrated.

Wall mounted nozzle

For wall mounted system, the origin/default position is that the nozzle is pointing center (with $\pm 90^\circ$ horizontal movement), and level to ground (with $\pm 90^\circ$ vertical movement)

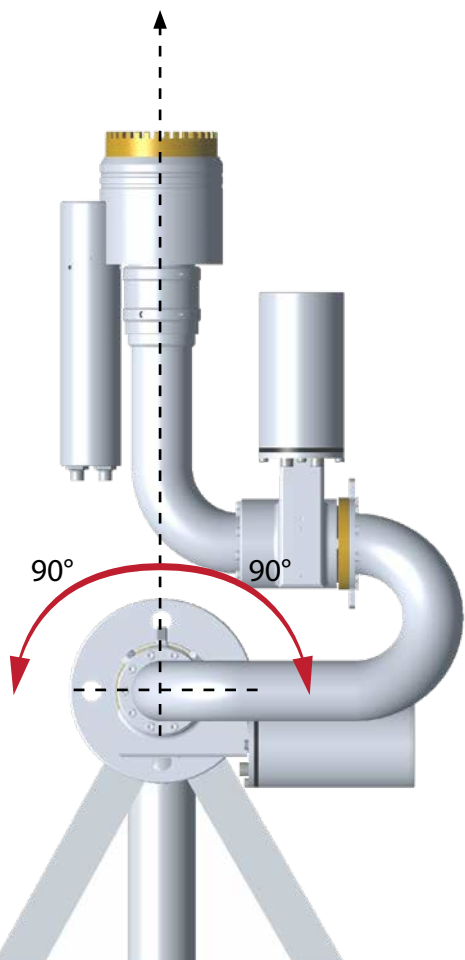
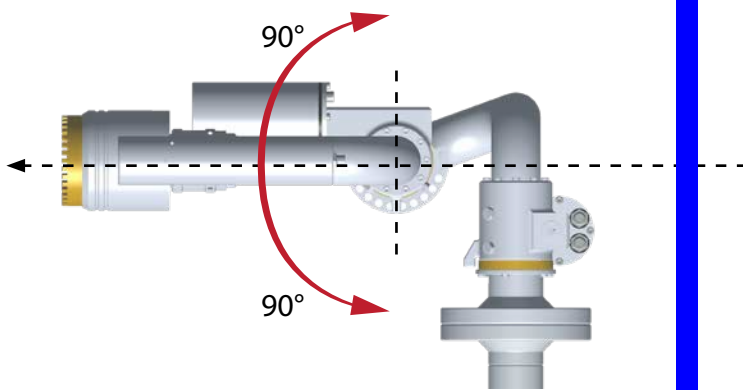

WALL (view from above)

Ceiling mounted nozzle

For ceiling mounted system, the origin/default position is that the nozzle is pointing straight down on both axes.

Follow the step-by-step instructions on the following pages to calibrate the motors.

CEILING (view from the side)

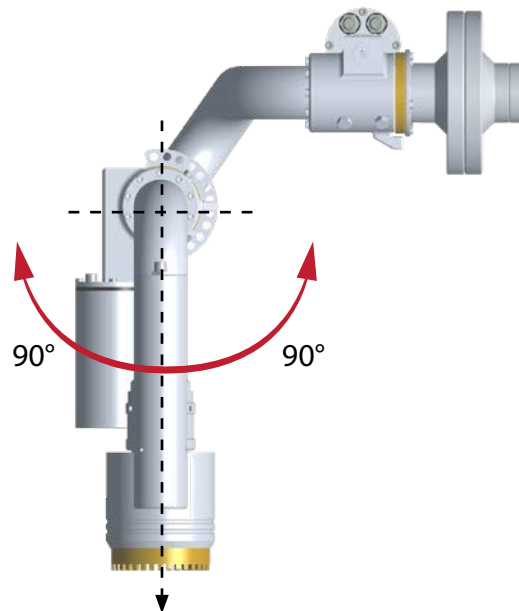

CEILING (view from the side)

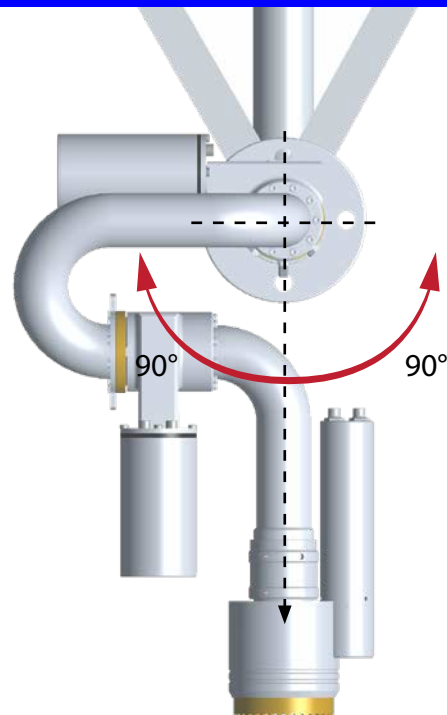



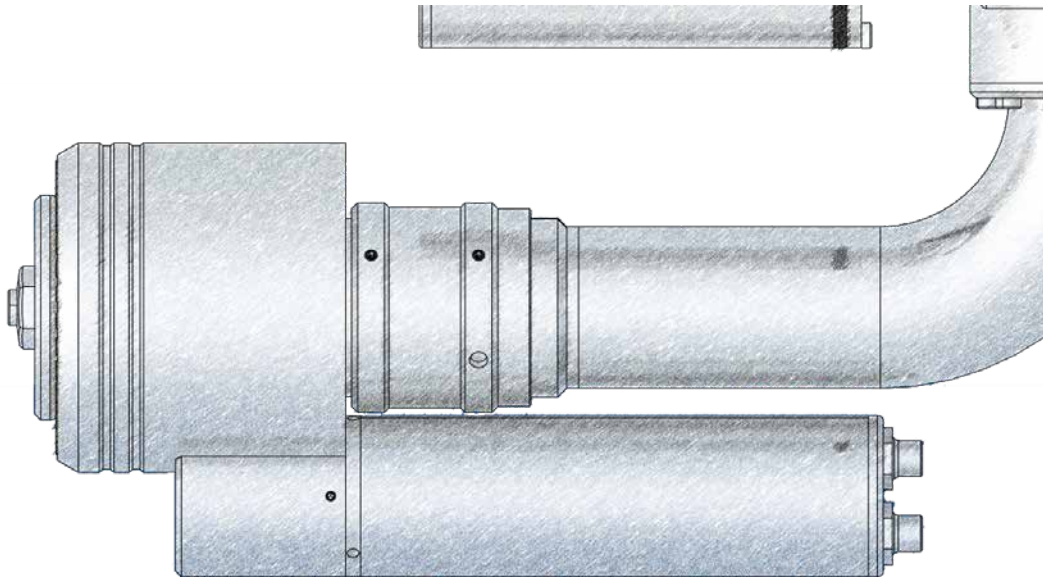

Set the nozzle minimum (Motor 6)

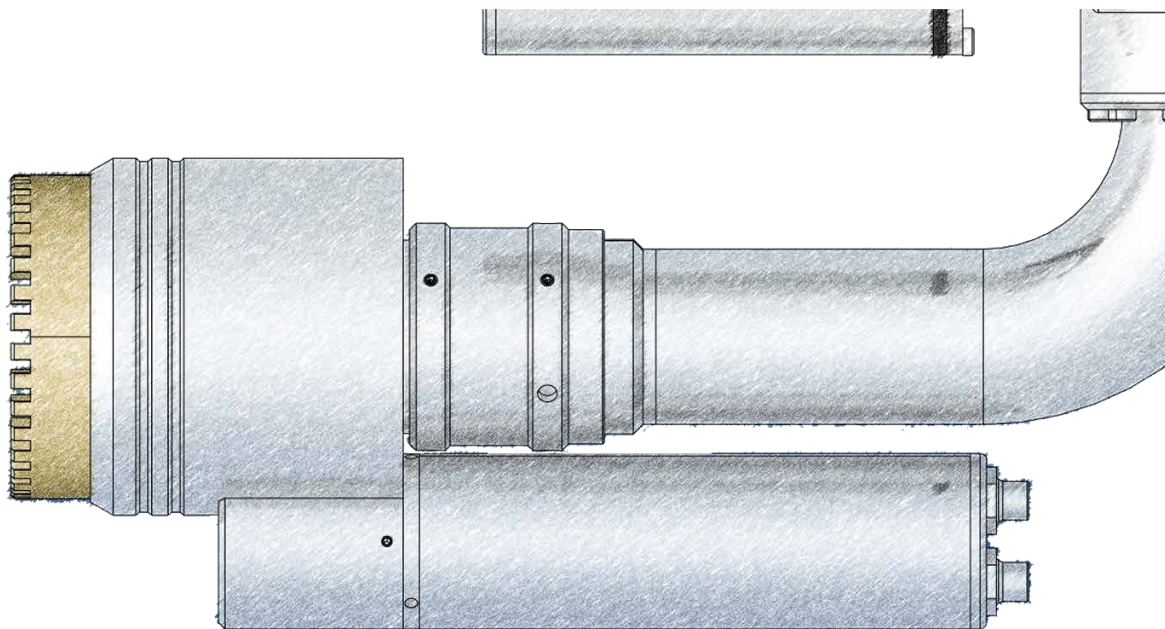

Set nozzle maximum (Motor 6)

Step-by-Step Instructions

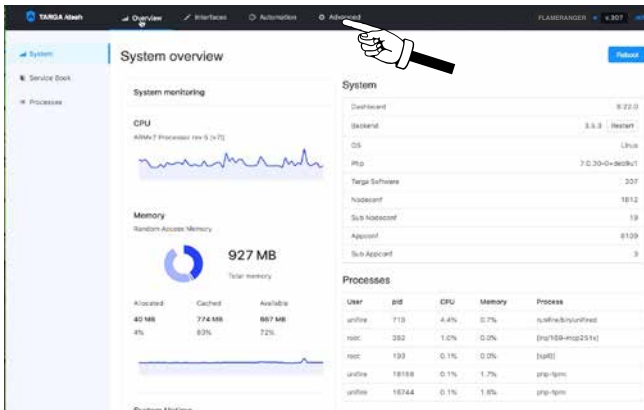

1/ From the TARGA/dash page, click Advanced.

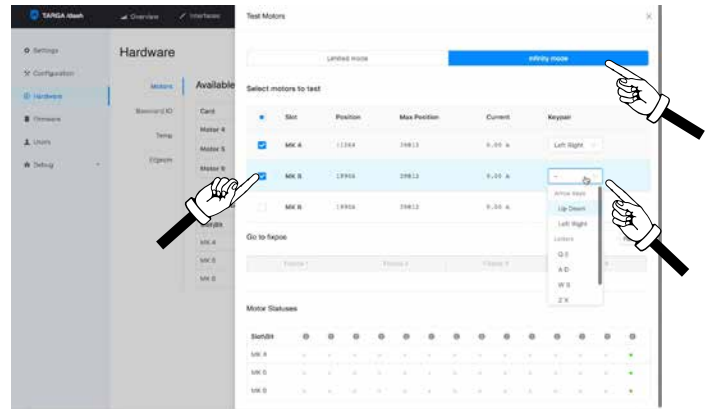

4/ .. this opens up Test Motor window. Choose Infinity mode. Check the boxes next the motors you want to test. Assign keypair to the motors.

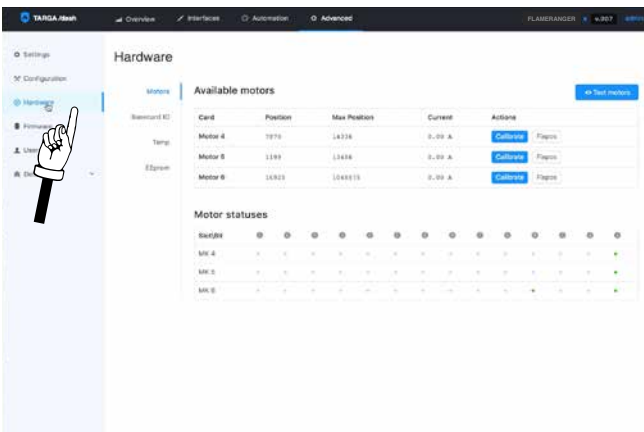

2/ .. Next, click Hardware.

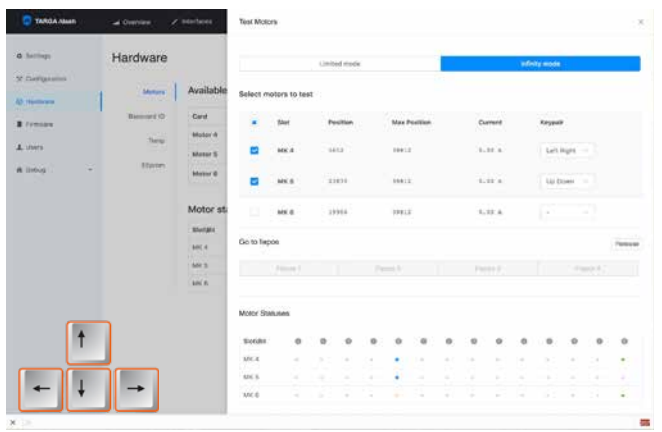

5/ .. using the assigned keypair you run the motors until the monitor is roughly facing down on both axis.

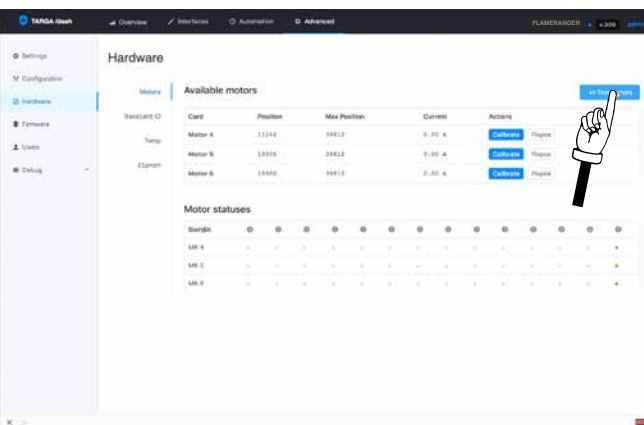

3/ .. Next, click Test motors.

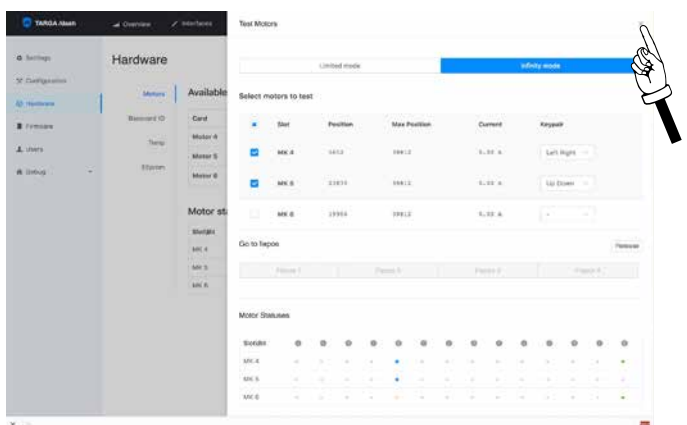

6/ .. Exit Test motors.

Step-by-Step Instructions (Continued)

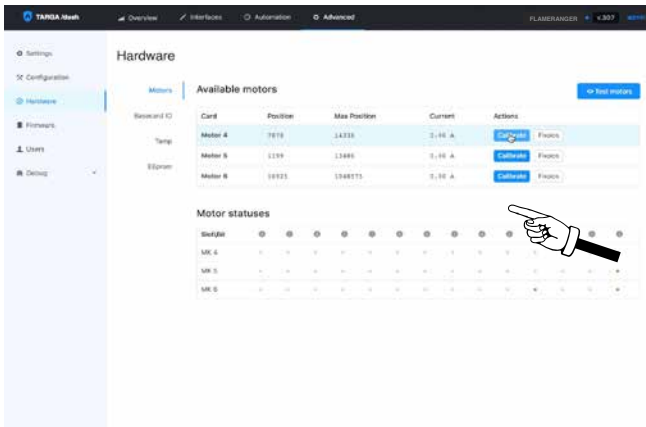

7/ .. Now choose the motor you want to calibrate:
Mk 4 = Rotation, Mk 5 = Vertical, Mk6 = Nozzle.
In this example we start by Mk 5 (motor 5, Vertical)

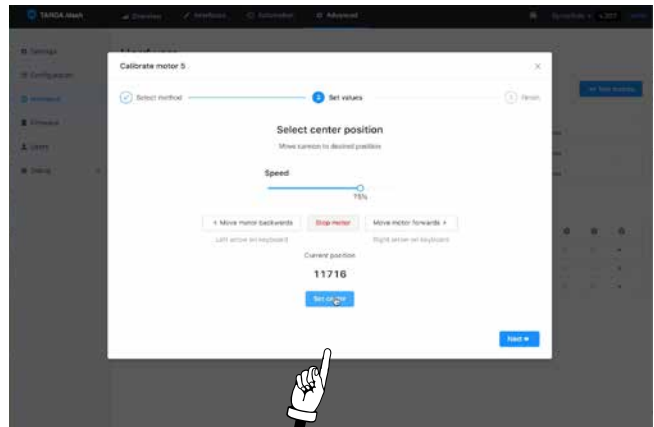

10/ ... When the monitor is in the straight down position, confirm by clicking Set center. Then click Next..

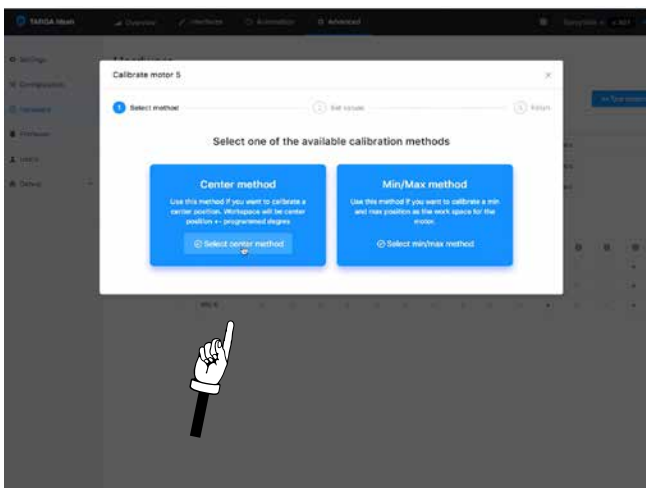

8/ For this motor, click Select center method.

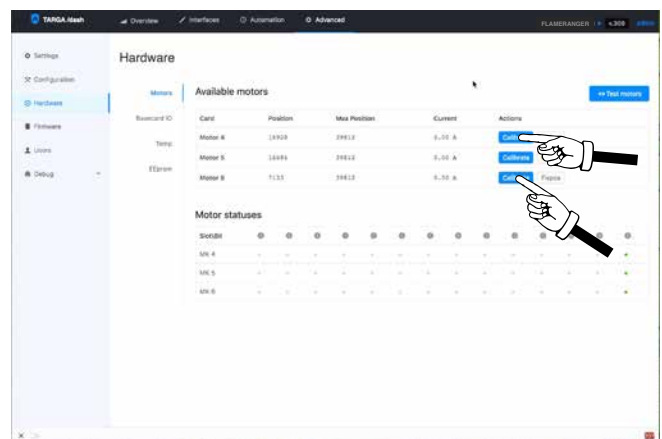

11/ Then repeat the sequence 7-10 for Motor 4 (vertical)

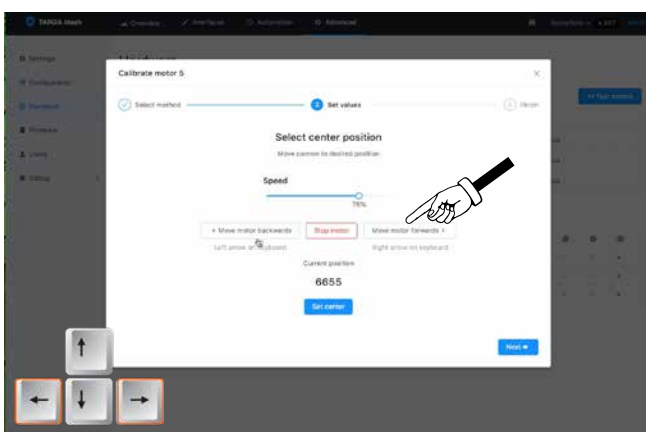

9/ Use the arrows on your keyboard (or the screen buttons) to adjust the motor/axis until the monitor is exactly straight down. Verify by measuring accurately,

Calibrating the INTEG jet/spray nozzle

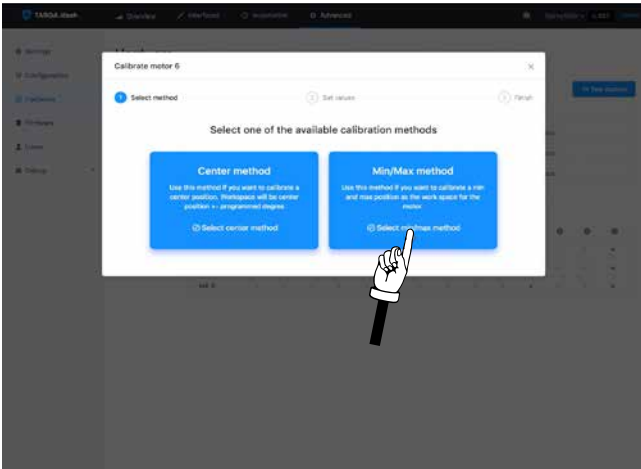

1/ Next, calibrate the INTEG50 jet/spray tip. We choose motor 6. Min/Max method.

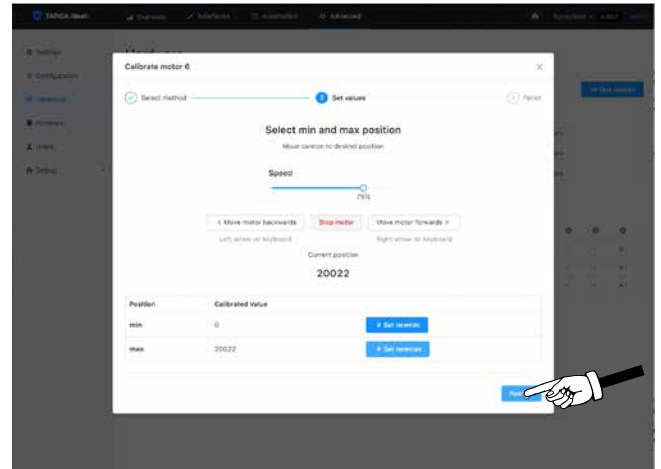

4/ When the new min, and new max have been selected, click Next.

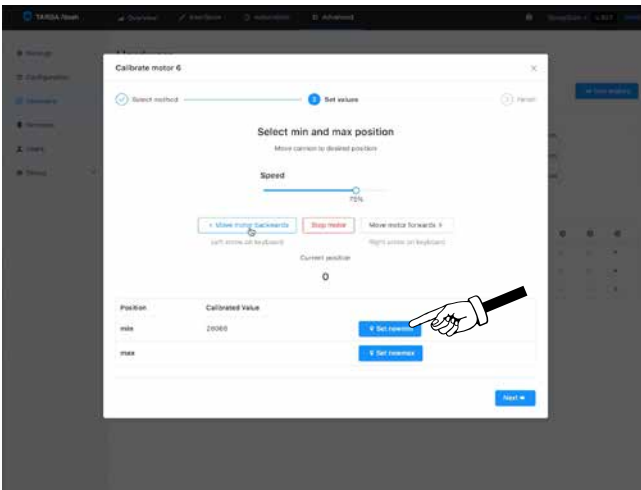

2/ Run the motor to the most inward mechanical stop (full spray). Back off about 500 pulses, and click Set new min.

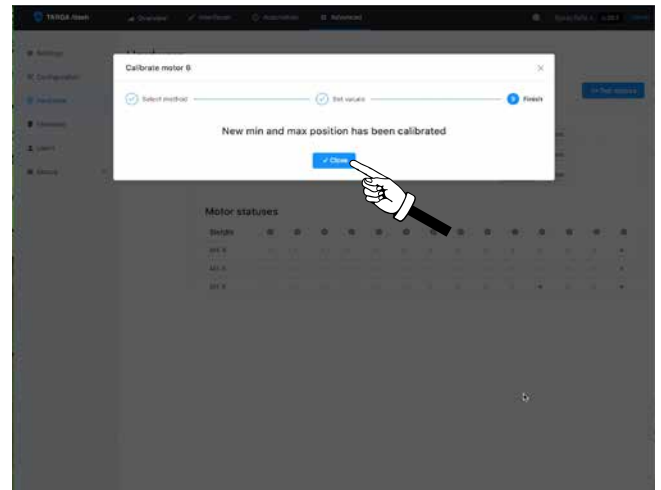

5/ If successful, you will see a window confirming new min and max have been calibrated. Click Close.

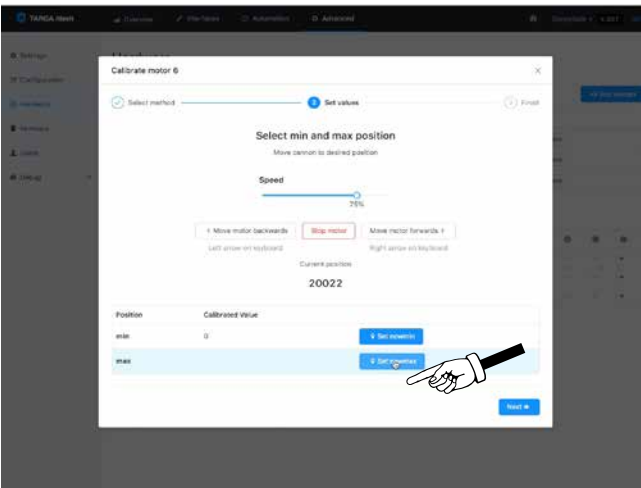

3/ Run the motor to the most outward mechanical stop (full straight stream). Back off about 500 pulses, and click Set new max.

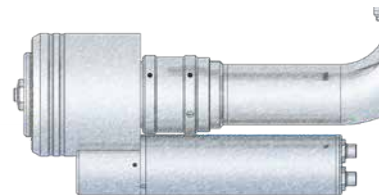

Set the nozzle minimum (Motor 6)

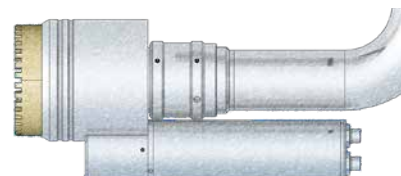

Set nozzle maximum (Motor 6)

Set parking position

When the fire is out, and the valve closes. The robotic nozzle will return to it's predefined parking position.
Follow these steps to save a predefined parking position.

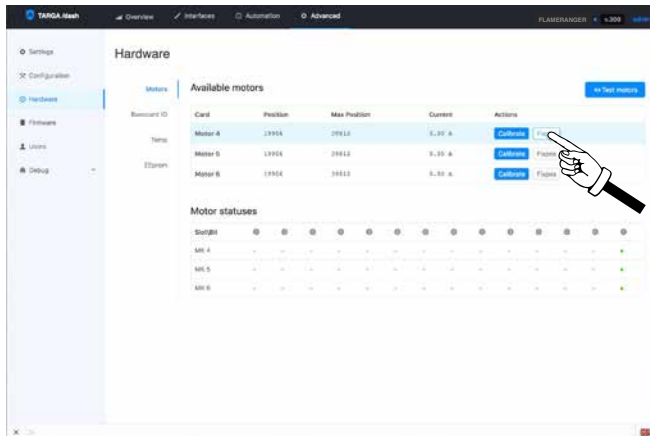

1/ For Motor 4 (rotation), click Fixpos.

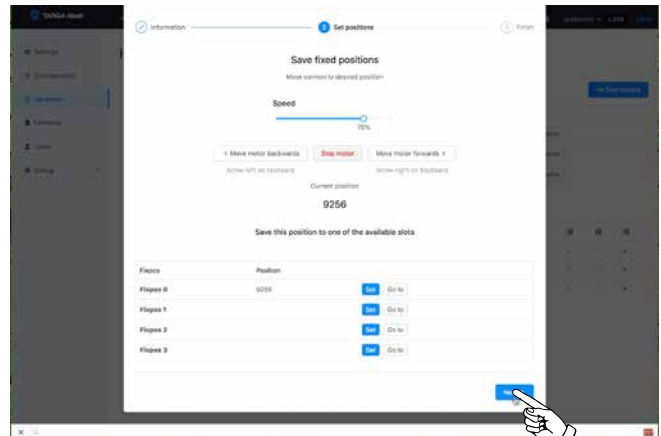

4/ Click Next

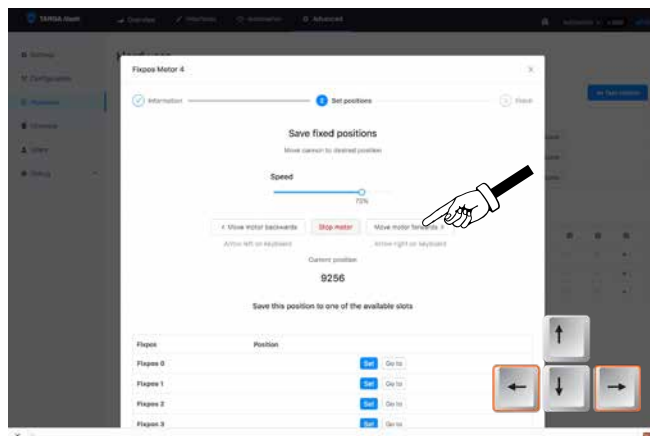

2/ For Motor 4 (rotation), you can move the motor to the to-be parking position, using the arrows keys.

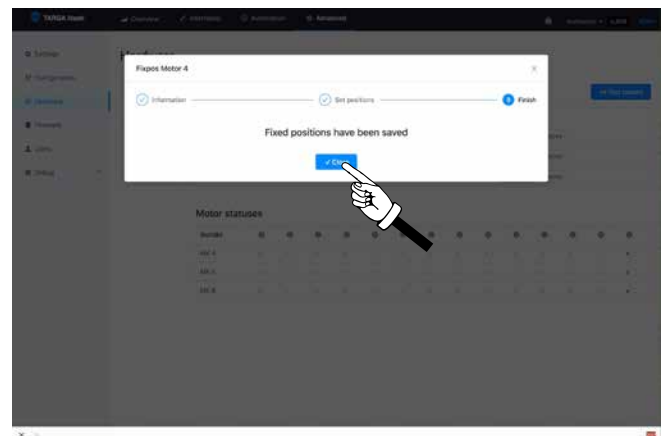

5/ You will see a window confirming a new Fixed position has been saved. Then click Close.

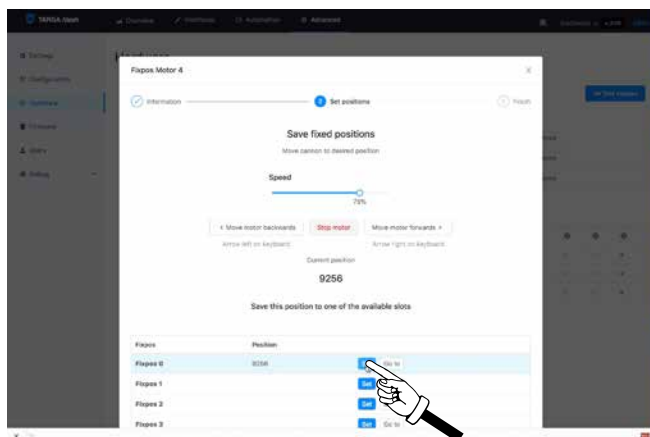

3/ Then click Set. This saves the current position as predefined parking position (Fixpos 0)

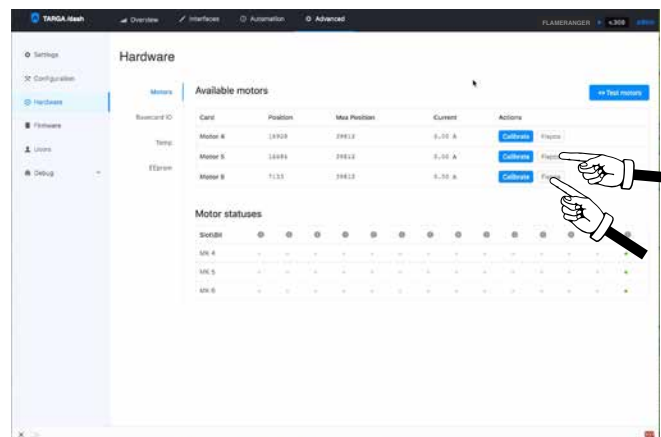

6/ Repeat steps 1-5, for motor 5 and 6.

Verify parking position

After the parking positions for motor 4,5 and 6 have been selected, you will want to verify the parking position.

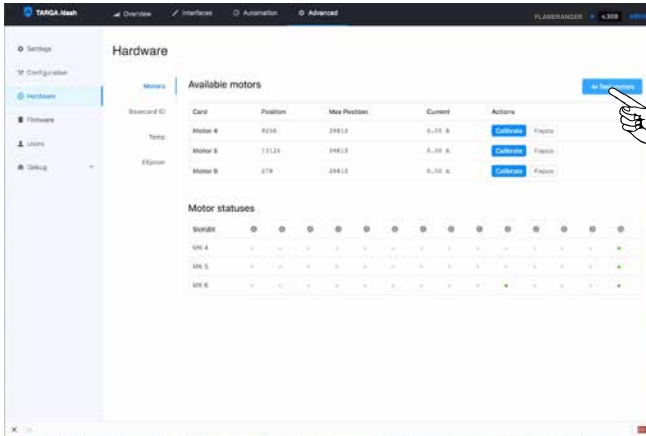

1/ Click Test Motors

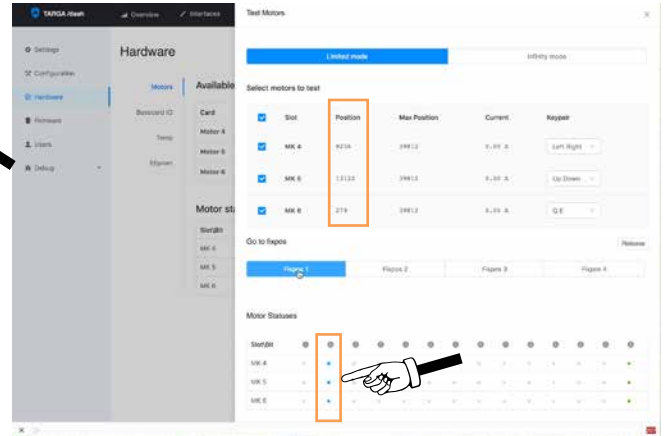

4/ "At parking position" is indicated by the blue indicators in the second column. The position values should be identical with what was selected as parking position.

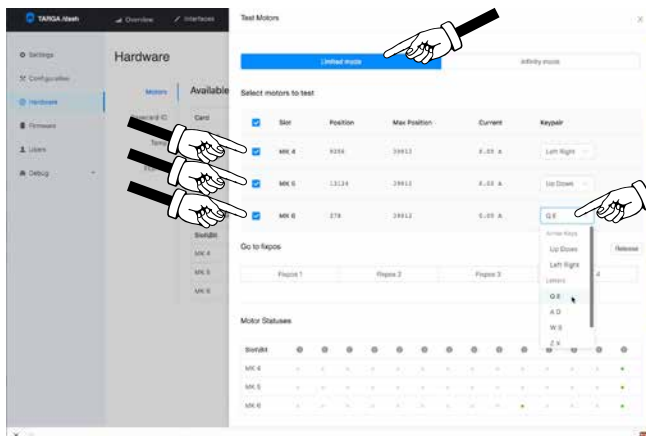

2/ Stay in Limited mode. Check all 3 motors to test. Assign key pairs to run the motors, so that all 3 motors are moved out of parking.

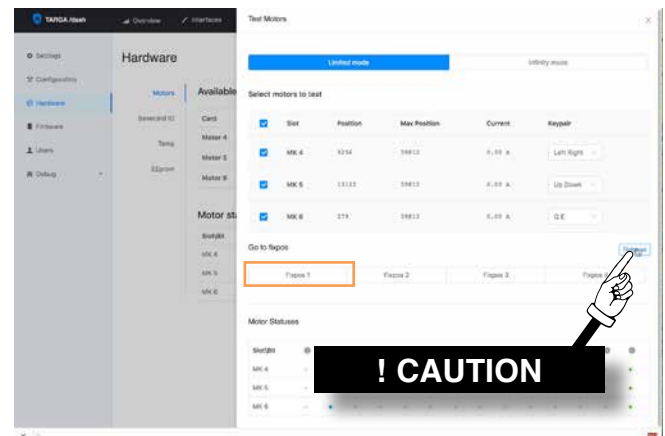

5/ After testing the parking position, you MUST click Release, to unlock parking. The system will not work, if not manually released. Fixpos 1 indicator must be white.

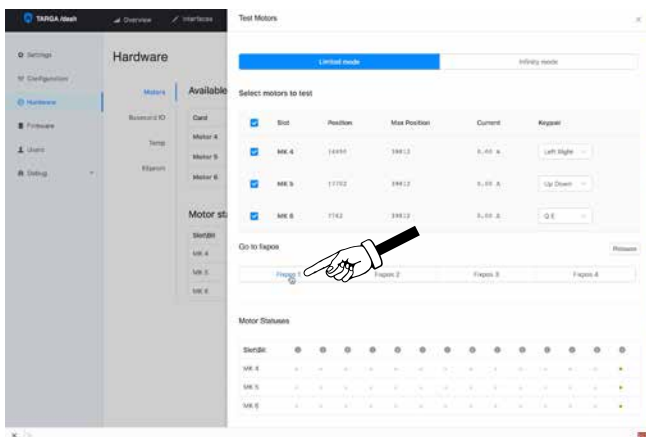

3/ Under "Go to fixpos", click Fixpos 1. This sends all 3 motors to the predefined parking position.

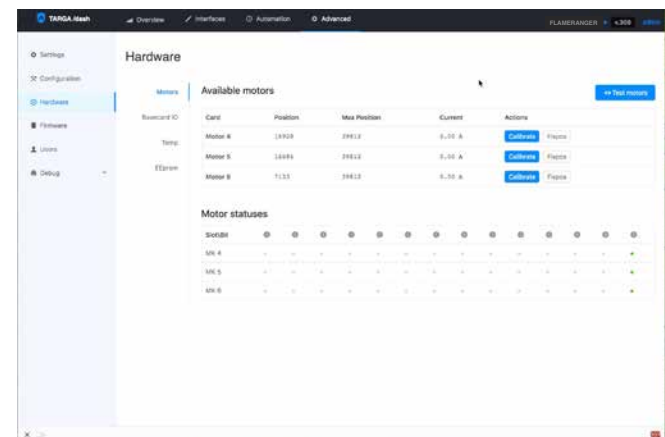

6/ Close "Test Motors", and return to the Hardware window. In the Hardware window a technician can follow the statuses of individual motors. Current. If it's parked or

Status windows, Service book, rev versions etc..

There is a lot of data and information available for advanced and qualified users, for example;

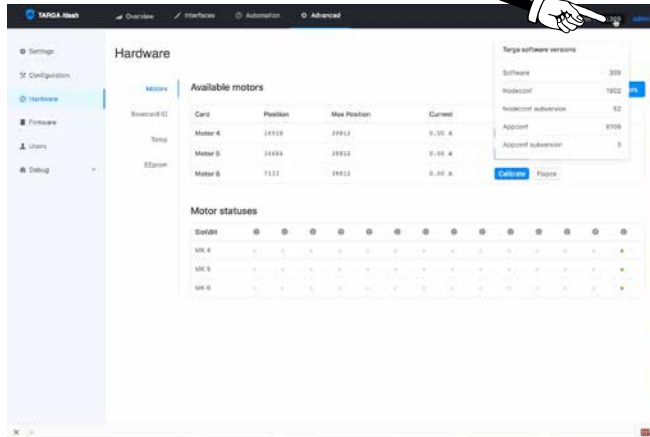

Click version number to open a drop-down window. This will show what software and revision your system is running

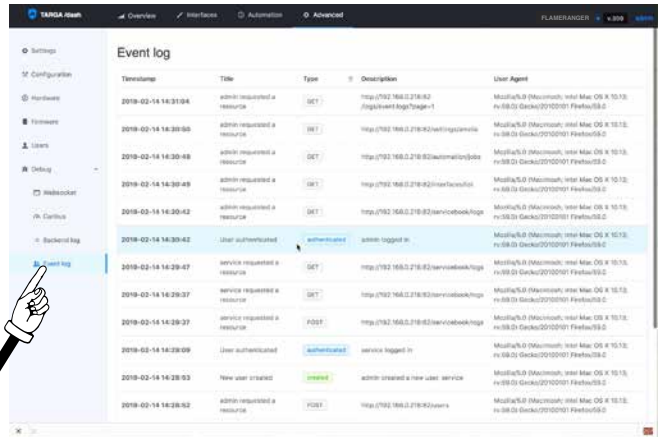

Under the event log you can see what has happened with the system. This data is overwritten every 24 hours, but can be saved to a “black-box” server for archiving.

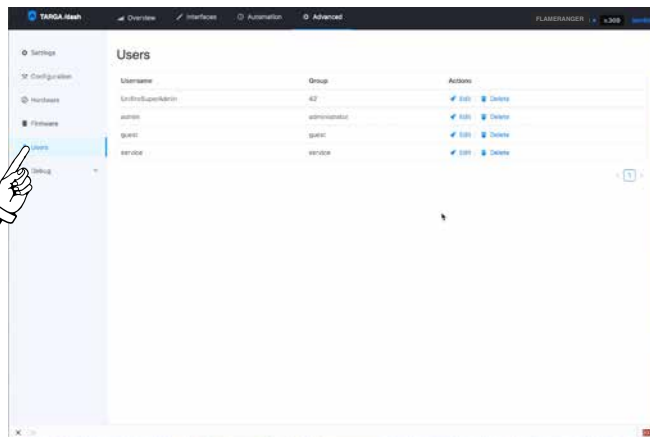

Under “Users” you can find and administrate different levels of users. Edit and assign levels of access and clearance.

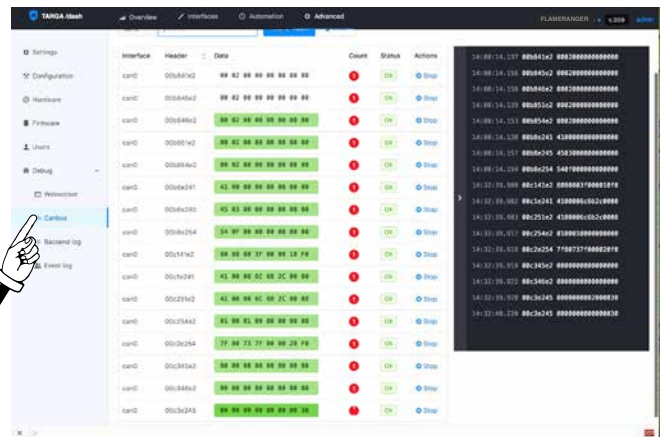

Under Canbus (canbus listener), a qualified technician can in real time follow the Canbus messages in the PLC.

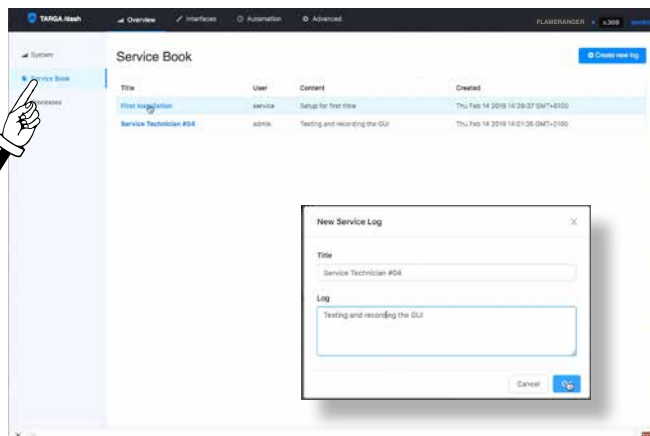

Under “Service book”, you can see who has logged in to the system. It is required by the system that a Service Technician level user must write in the Service Book.

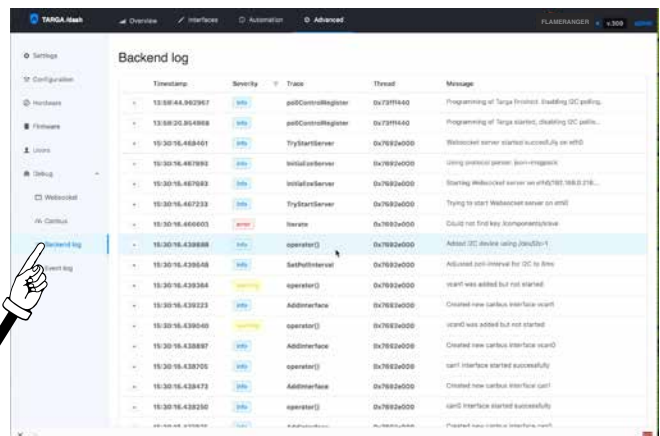

Under the Back end log, a qualified technician can track the activities on the PLC back end.

Notes:

COMMISSIONING

**After completed installation and software setup,
Verify that the system is correctly installed and
working properly by following these instructions.**

System Verification

To verify that the FLAMERANGER AFS system operates correctly, complete the following steps:

! CAUTION

Verify that the PLC is powered on

1. Turn the power on using the switch in the PLC cabinet.
This activates the lights which should blink on the PLC.

Verify that the web interface displays and is operational

1. Navigate to the web interface screen and login with the appropriate credentials.
2. Confirm that no errors display near the top of the screen stating there is a problem with the web socket connection.
3. If errors appear, see Section 8 - Troubleshooting.

Verify that the detectors operate and receive power

1. When the system's power is turned on, the alarm (red) and fault (yellow) LEDs both turn on briefly. The alarm LED turns off and the fault light remains on for a few more seconds while the detector performs internal self-tests. The fault LED blinks when the sensors are settling. This settling process can take approximately 20 minutes.
2. If the detectors fail to settle, the fault light turns on and a fault signals on the outputs.
3. If any errors occur, see Section 8 - Troubleshooting.

Verify that the robotic nozzle operate and move



CONFIGURING THE FV300 DETECTORS

This section is provided for reference only.

CAUTION:

Normally the FV300 detectors have been configured and tested with the specific FLAMERANGER system prior to delivery.

Manual configuration of the FV300 may only be done if specifically requested by UNIFIRE.

Configuring the detectors

The flame detector's configuration options are set independently using the *FLAMEVision PC400 Configuration Tool*, which connects to the detector using an RS-485 link through an interface unit.

Note: Configuration tool and login information are only provided to authorized and trained personnel.

To configure the detectors, complete the following steps:

1. Connect the FV300 to your computer using RS-485 to USB converter (Part number TBC).
2. Log in to the configuration tool with the user name and password provided in your training. Contact your local technical support team to retrieve any forgotten login information.
3. Select **FV300** from the drop-down menu (see Figure 6-1).
4. Select the correct **COM** port and click **Connect**.

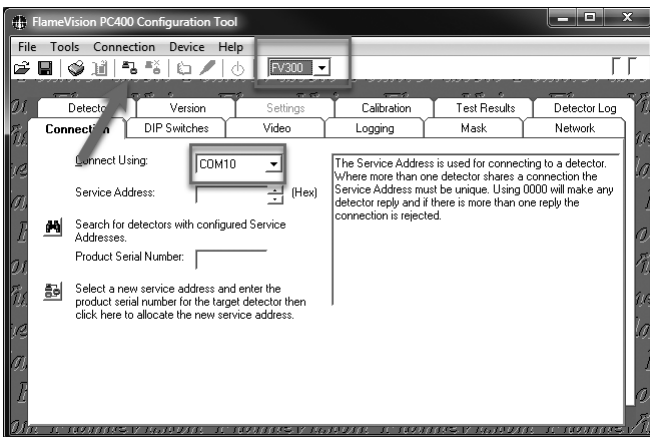

FIGURE 6-1
CONNECTION TAB
E000537

5. Confirm the following settings in the **DIP Switches** tab (see Figure 6-2):

- Alarm Delay: Medium
- Alarm Latching: Non-Latching
- Fault Latching: Non-Latching
- OPM Mode: Auto & Manual
- OPM Timer: 20
- Window Heater: On (optional)

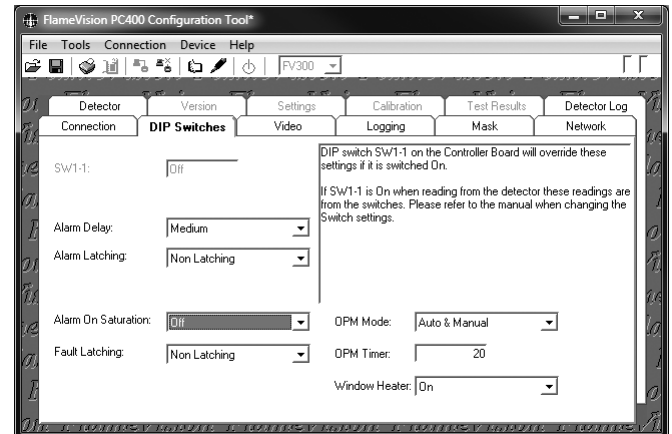

FIGURE 6-2
DIP SWITCHES TAB
E000538

6. Confirm the following settings in the **Network** tab (see Figure 6-3):

- Modbus: Enabled
- Baud Rate: 9600
- Slave Address: 1 or 2 (see note)
- Address Offset: 0000
- Parity: Even

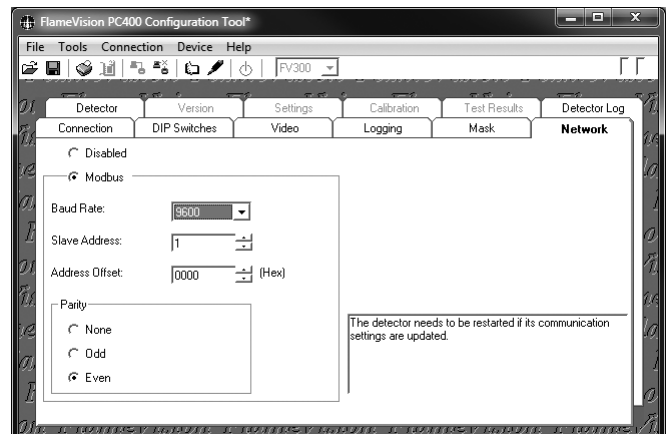

FIGURE 6-3
NETWORK TAB
E000539

7. Click the **Write** icon and follow the prompts.
8. Click the **Reset** icon to confirm changes.

This completes the detector configuration file. See the *help guide* included as part of the software for additional advanced configuration options.

Note: The detector installed on the left side of the building, from the perspective of a person looking at the building from the outside, must be addressed **1** and the right side detector must be addressed **2**.

FV 300

FLAMEVision Array Based Infrared Flame Detection

The FlameVision detector utilises infra red array based flame detection combined with integral CCTV to automatically and reliably identify flame incidents and pin point the location on a video image.

By using an array as the sensing component, the FLAMEVision detectors are able to locate the angular position of the fire within the field of view. The detectors use this information to provide superimposed location information on a composite video output from an internal CCTV camera and to signal the coordinates of this location on its data output. This information allows the operator to quickly verify the alarm and implement the necessary actions. It also provides a valuable tool for false alarm control and event audit processes.

The FLAMEVision offers a major improvement in both flame detection capability and immunity to false alarm sources over triple IR detectors. It also includes features designed to reduce maintenance requirements.

The FLAMEVision range of detectors provide, as standard, the following system interface:

- // Volt-free relay contacts for alarm and fault, programmable as normally open or normally closed
- // An analogue output current, in the range 4 to 20mA, proportional to the flame detection signal.
- // RS485 serial data port suitable for network connection using a MODBUS protocol.
- // Video output compatible with twisted pair video cable.



Features:

- // Built-in CCTV option to assist with rapid response
- // Fast, reliable flame detection using infra red detection
- // Simplifies alarm handling for remote control room situations
- // Provides immediate visual ID of alarm location
- // Robust housing with heated optics
- // Automatic monitoring of detector functionality including signal transmission through window status
- // 256 infra red sensor array monitoring the field of view to separately identify flame and non flame sources
- // Range of integral interface options
- // Masking of part of field of view in software configuration tool
- // Over 50m detection range with 90° field of view
- // Remote video monitoring with fire location and detector information
- // Automatic Optical Integrity Monitoring

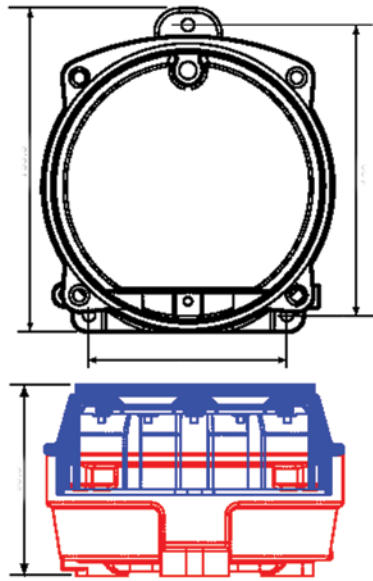

FLAMEVision Dimensions

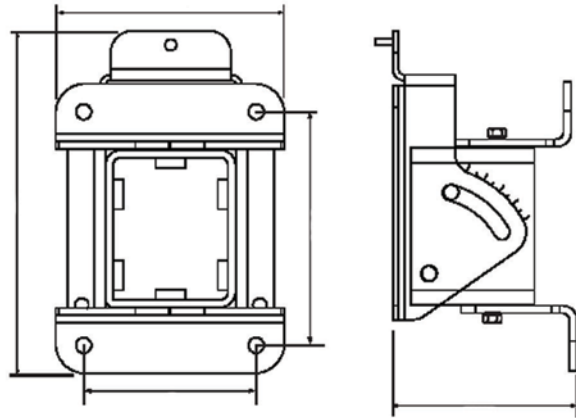

Adjustable Mounting Bracket and Surface Mounting Dimensions

Mechanical

Dimensions

Height:	155.5 mm
Width:	152.0 mm
Depth:	92.0 mm
Weight:	4 kg
Mounting bracket	
Weight:	1.54 kg

Materials

Enclosure:	Stainless steel 316L, ANC4BFCLC to BS3146: Part 2
Detection window:	Sapphire
Camera window:	Toughened glass
Guard/label plate:	Stainless steel 316S16 to BS 1449: Part 2
Mounting bracket:	Stainless steel 316S16 to BS 1449: Part 2

Screws etc. Exposed to the elements: Stainless steel 316 A4

Electronic modules: Fibreglass substrate

Electrical access

FV311 series detectors:	Standard M20 gland holes (two)
FV312 series detectors:	Multi twisted pair screened cable

Interface outputs

Modbus / 4-20mA / Fire and fault relay / Video Out

Environmental Characteristics

Temperature

Operating temperature range without camera:
-40°C to +80°C

Operating temperature range with camera:
-10°C to +55°C

Maximum withstand temperature:
120°C (for 10 minutes)

Storage temperature range:
-40°C to +80°C

Humidity

Relative humidity: Up to 99% (non condensing)

Enclosure Protection

Enclosure protection: Tested to IP66 and IP67

Pressure

Normal operating atmospheric pressure: 910 mbar to 1055 mbar

Heat Radiation

Heat radiation from sun: 0 to 1kW/m² typical

Camera Specification

Composite video:	(1V p-p) into 75 Ohm
Horizontal resolution:	Standard 450 TVL
Light Sensitivity (-30 IRE):	0.3 Lux
Iris / Exposure control:	Electronic 1/50 - 1/100,000 sec